

international electronic music

# Synapse

Summer '78  
Volume 2, Number 6  
USA & Canada \$1.50

**DEVO**

**Frank  
Zappa**

**Don  
Preston**

**Guitar  
Synthesis**

*From the ground up*

**Laser  
Sculptures**

*Where to find an*  
**Electronic  
Music  
Education**

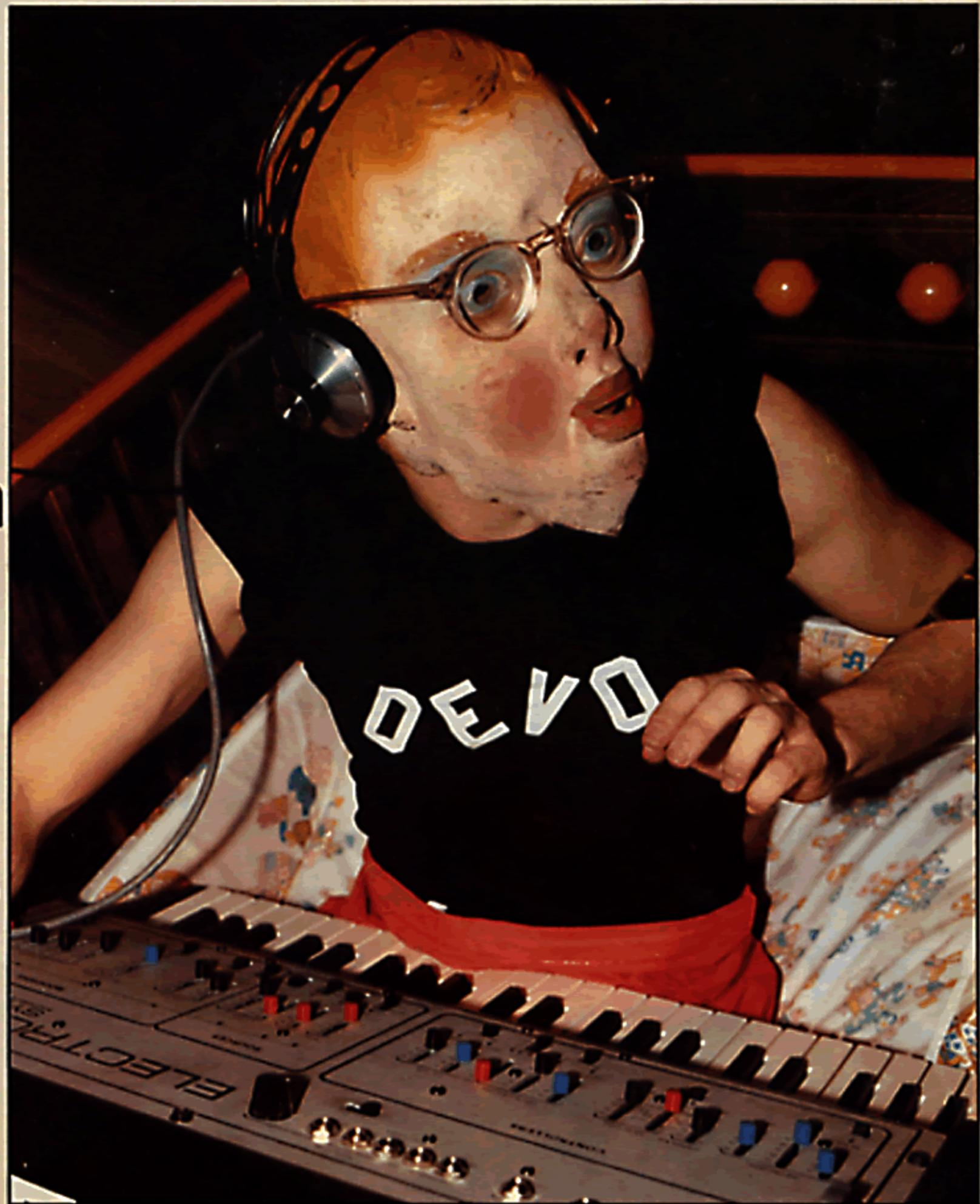

PHOTOGRAPH BY BRUCE CONNER

**Reviews:** David Bowie, Steve Hackett, Michael Hoenig, Kraftwerk, Hawkwind, Screamers, Eela Craig, & Equipment

# the Synclavier

*New England Digital opens the door to the exciting world of complete digital music synthesis with the introduction of the Synclavier. A powerful 16-channel all-digital synthesizer uses Linear FM and Arbitrary Wave Capability to create a wealth of new timbres that are unattainable with analog equipment. Construct entire compositions in memory and store them on floppy diskettes. Precision, repeatability, instant recall . . . all available now from New England Digital. Write for our Synclavier Instruction Manual (\$2.00) or complete System Reference Manual (\$25.00).*

**NEW ENGLAND DIGITAL CORPORATION**

P.O. BOX 305 NORWICH, VERMONT 05055 (802) 649-5183

Editor  
Douglas Lynner

Art Director  
Chris August

Managing Editor  
Melodie Bryant

Photography  
Bill Matthias

Contributing Editors  
Chris August, Colin Gardner

Contributing Writers  
Melodie Bryant, Greg Burk, Andy Capraro, Alex Cima, Robert Devoe, Colin Gardner, Franc Gavin, Pat Gleeson, Peter Hillen, Rodney Oakes, Ron Pellegrino, Ernie Perevoski, Vicky Reeslund, Danny Sofer, Dan Wyman

Production  
Colin Gardner, Bill Matthias,

Contributing Artists  
Curtis Abrue, Sue Denim, Robert Devoe, Bill Matthias

Contributing Photographers  
Jackie Devoe, Ellen Buzzell, Tim Griswold, Pat Gleeson, Amando Gallo

Correspondents  
Boston: Kenneth Perrin  
Northern California: Phil Loarie

Chicago: John Parris Frantz  
Connecticut: Chuck Scribner

Louisiana: Tony Prestigiacomio  
Maryland: Paul Medlock

Minneapolis: John Borowicz  
New York: Carter Thomas

Oklahoma: Richard Bugg  
San Diego: Steve Roach

Texas: Barton McLean

Western Canada: Jerry Ozipko  
Columbia: Luis Guillermo Restrepo R.  
England: K.S. Dulay

West Germany: Christian Charles Kneisel  
Japan: Eiji Ueda  
Sweden: Gregory Allen Fitzpatrick

Cover Photograph  
Bruce Conner

Courtesy of Different Fur

Synapse is published bi-monthly at 2829 Hyans Street, Los Angeles, CA 90026 by Synapse Publishing Co. The entire contents of Synapse are copyright © 1978 Synapse Publishing Co., all rights reserved, and may not be reproduced in any manner, either in whole or in part, without the written permission of the publishers. Application to mail at second-class postage rates is pending at Los Angeles. Manuscripts, photographs & artwork: All contributions are welcome, however, we cannot be responsible for the return of unsolicited materials. Enclose a self-addressed stamped envelope with any contributions and send to Synapse, 2829 Hyans Street, Los Angeles, CA 90026. Advertising Contact Doug Lynner or Chris August at: (213) 383-7933 for our current rate and deadline schedule. Distributors & Dealers: Contact Chris August or Doug Lynner at (213) 383-7933 for discount information and publishing schedule. Subscriptions: Within the US the annual six-issue rate is \$8.00. A domestic first class mail subscription is available for \$14.00 yearly. The one year foreign subscription rate (by surface mail) is \$10.00. A special foreign air mail subscription is now available for \$20.00 annually. Single copy newsstand price is \$1.50 in the US and Canada; Australia, Europe, and Japan \$2.00. Back Issues: We are presently sold out of most issues. Please send a postcard for our files naming the issues you lack and they will be reprinted when demand is sufficient. Change of address: Notify Synapse/Subscriptions at 2829 Hyans Street, Los Angeles, California 90026. We are not responsible for issues lost when we have not received an address change notice. Please send both the old and new addresses, and if possible, the mailing label from your copy of Synapse.

# Frank Zappa

*A Mother Speaks Frankly,*  
—Part One.— Chris August — 25



CURTIS ABRUE



# Devo

*Are They Not Men?*  
*Spudboys Speak Up.*  
—Pat Gleeson— 26

# Cameron Jones

*The Making of an Instrument.*

—Doug Lynner— 30



# Don Preston

*Synthesist.*

—Doug Lynner— 34



# Let There Be Light

*Composing Dynamic Laser Light Sculpture.*

—Ron Pellegrino— 29

# Looking For an Electronic Music Class

*Notes for the Novice.*

—Rodney Oakes— 36

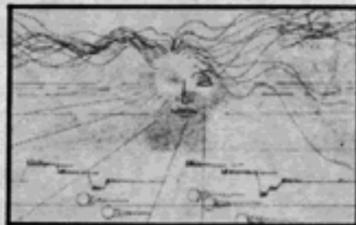

# On Keeping Score

*Creative Concepts in Notation.*

—Robert Devoe— 40

Letters Reader feedback . . . . .	4	Profile Steve Hackett,	
What's Happening Around		<i>The Screamers</i> . . . . .	22, 23
<i>the world</i> . . . . .	6	Equipment <i>The Prophet, The</i>	
<i>Discola Michael Hoenig, Steve</i>		<i>Cat SRM, Synare 3</i> . . . . .	44
<i>Hackett, Kraftwerk, Hawk-</i>		Guitar Synthesis . . . . .	46
<i>wind, Eela Craig,</i>		Advertising Index . . . . .	45
<i>Iowa Ear Music &amp;</i>		Computers <i>Computer Controlled</i>	
<i>New Releases</i> . . . . .	11	<i>Triggers &amp; Gates</i> . . . . .	48
Performance <i>David Bowie</i> . . . . .	21	Listings <i>Addresses of interest</i> . . . . .	49

# LETTERS

## Live From Oklahoma

I found out about the magazine from Richard Bugg, your Oklahoma correspondent, and I am looking forward to the first issue I receive.

Sometimes Oklahoma can seem pretty culturally stagnant and it's nice to run into someone like Richard, who is actually involved in live electronic music. Keep up the good work!

Dennis Borycki  
Norman, Oklahoma

## A Small World

I first heard of your magazine in a brief mention in Rolling Stone. I got your address from the Electronic Music Department at Berklee College of Music, where I am a student. My teacher says it's a fine magazine.

Leslie Nathan  
Boston, MA

Thanks for finding us, and thanks to Rolling Stone and Berklee for helping. Ed.

## More Classical Techniques

I was very pleased to discover your magazine. I've been an electronic music enthusiast for many years, and Synapse is a kind of electronic oasis in this Midwest wasteland.

I would like to add my support to the suggestions of Robert J. Dicomillo printed in your "Letters" column in January/February. He suggests more articles on the major figures and achievements of "serious" electronic music. More reviews of serious electronic music albums would also be appreciated.

I have a suggestion that will probably not interest most of your readers as well. I would like to see practical "how-to" articles on the techniques of "musique concrète". I, for one, do not think that synthesizers have rendered the "classical" approach obsolete. Your magazine seems oriented to the live performer, and most have no interest in the laborious methods of earlier pioneers, but perhaps there are a few of us left.

One other suggestion: how about occasional book reviews?

In an unrelated area, I'm wondering if you can supply me with the complete mailing address of a small record company out of Berkeley, California called "Arch

Records"? They issue "avant-garde" stuff.

John K. Riordan  
Farmington, MI

Thanks for your thoughts. An article is in progress now that will up-date classical tape techniques to include the additional possibilities made available with contemporary equipment. I think that you will find it interesting. The address of Arch Records is, 1750 Arch Street, Berkeley, CA 94709. Ed.

## Wait A Minute

Well Mr. Froese [see Synapse V2N5 March/April—Ed.] we're so sorry that you didn't get your "formal recognition" for your boundless advances on the sequencer. We realize that you "studied" its use very diligently. So now why don't you go back and study it some more. Maybe by then you can find some new things to do. Anybody that calls ENO's work gimmicky certainly needs to study something, probably ENO!

Geny Rator  
DeKalb, Ill.

## Shocked by Synapse

I would like to say that your magazine is one of the best I have ever read, electronic music-wise or no. But I feel I must comment on a statement made by the publishers in the Jan./Feb. issue of this year. In your editorial 2:4, you make the statement, "Activity in interfacing traditional instruments to synthesizers has already been considerable, but the synthesizer still lacks a controller to call its own."

I am shocked, to say the least. I mean, what makes a synthesizer a synthesizer? Is it not the voltage running through circuits, is it not voltage control? The synthesizer does have its own controller, and it has been with us all the time. I willingly admit to infatuation with the expressive keyboard and guitar controlled synthesis of today's progressive artists, and also that I am hopelessly addicted to the ribbon on my own Micro-moog; but we must realize that true synthesis is the realization of electronic sound and has nothing

to do with the accepted enablers of art as other instruments have established.

The synthesizer is a new instrument, a progression on past instruments. Therefore, why shouldn't its art-enabling qualities be progressions of what already exists? Expression and nuance are traditionally controlled by the hands or the lips; but in the synthesizer, why not the pressure of brainwaves? And our musical scales. We all know there must be a progression on our present "semi-tones", and that is not too far in the future.

I am rationalizing aesthetically to a certain extent, but as long as we realize the potentials of the synthesizer as a true new instrument and separately, as an electronic adaptation of/for standard instruments, we will be able to fulfill the possibilities of both. Thank you for allowing me to express my concepts.

Jamie Yeotes  
Belleville, Ont.

I believe we both make the same point: that a need exists for further design in the area of synthesizer controllers. Ed.

## Great Expectations

Cheerfully enclosed is my payment for the three back issues. They have greatly surpassed the expectations I had when I subscribed, which were pretty high already. Would like to see more construction articles, equipment reviews and computer/synthesizer articles (of course, don't leave out the interviews). Especially appreciated are the manufacturer address listings.

Looking forward to forthcoming issues.

Mark S. Glimsky  
Orlando, Florida

## Not Just a Keyboard Magazine

Please find enclosed a check to cover the cost of a one year subscription to your magazine.

I have subscribed to CK since its beginning, but was never entirely pleased. Don't get me wrong—CK is a fine magazine, covering the entire keyboard spectrum. That, however, is the

problem. The material is so diversified that I find little of interest to me in each issue (due to my own restricted interest in the keyboard field, no doubt).

Your magazine, as advertised in the July '77 CK, looks more like what I want—contemporary, state-of-the-art electronic instruments and modern performers. So what the hey, I figured I'd give you a try. Surprise me!

Richard H. Rae, CET  
Empoia, Virginia

I hope Synapse has lived up to your expectations. Ed.

## Oh no, Space Beings!

Since I've subscribed to your magazine, my addiction to electronics has increased beyond the hope of return. My knowledge has also increased one hundred fold.

I cannot find the words to express my joy at finding a good EM magazine (your Earth languages aren't very accurate for conveying feelings), so maybe someday I'll send you a tape so you'll understand. Keep up the good work.

The Mad Synthesist  
Krindstast, System 27-X2

## What A Find

Just discovered your fine publication through a friend who subscribes. I am currently keyboardist with Magik Dayze, a semi-pro act on the verge of breakout, currently negotiating with record people. Synthesizer-wise, I use EML and Moog gear, with Mellotron, Hammond organ, and electric pianos. Our signal processors include Eventide Harmonizer, MXR Phase 100, Synthtech Phaser and Echoplex. Our guitarist owns a 360 Slavedriver.

It's really great to see a magazine like yours, since Contemporary Keyboard doesn't always go into detail on electronics.

Articles I wouldn't mind seeing: background on tape-system instruments—Mellotrons, Chamberlins, Birotron, etc., interviews with Patrick Moraz, Larry Fast, Rick Wakeman, Mike Pinder (Moody Blues), Walter Carlos, Tony Banks (Genesis), EML, RMI (K.C.) etc. (I'm sure you've already considered these.)

Chuck Thaxton  
Fostoria, OH

# FINALLY.



You're a keyboard player, and a good one. That's why you deserve a synthesizer that gives you control. One that responds to your hands, and the technique you've perfected. An instrument that allows and encourages creativity, and lets you play *music*. In short, the all-new Yamaha CS-80 Polyphonic Synthesizer.

The CS-80 is velocity sensitive and pressure sensitive. The volume and brightness, as well as the character of the sound is in your hands.

You have control not only over the notes you play, but also the 22 internal preprogrammed voices, including Strings, Brass, Clavichord, Organ, Electric Piano, Electric Bass and Guitar. The voicings and settings are

## A SYNTHESIZER THAT PLAYS AS GOOD AS YOU DO.

easy. But your creativity is never compromised: adjust envelope characteristics, filters and equalization, vibrato, pitch and touch response so that you get your taste, not somebody else's.



# YAMAHA

P.O. Box 6600, Buena Park, CA 90622

Four memory banks let you summon the voices *you've* created and preprogrammed.

Because the CS-80 is a polyphonic synthesizer, eight notes can be played simultaneously, generated by 16 oscillators. And with two channels you get the added flexibility of producing two different voices in any mix you want.

You'd expect a one-of-a-kind synthesizer to come from the people who've been perfecting musical instruments for nearly a century. Write for a free brochure. Or try a first: play *music* on a polyphonic synthesizer. The CS-80. Or try the CS-60, or the CS-50. They're all polyphonic, and they're all at your Yamaha dealer.

# WHAT'S HAPPENING

... **November 1-5, Northwestern University** will host the **1978 International Computer Music Conference**. Addressing many aspects of the computer music field, activities will include papers, concerts, special interest groups, displays and demonstrations. Interested composers and researchers are invited to share their work. The deadline for the submission of papers is August 1; for compositions, September 1. All inquiries should be sent to: Peter Gena and Gary Kendall, School of Music, Northwestern University, Evanston, IL 60201 .....

... **FRAP** announces the July 1 release of the **GT**, a new version of its model T system transducer, for amplification of any round-hole, flat top guitar. Available for \$150.00, the GT is a complete prewired kit which can be installed professionally or at home .....

... May saw the formation of **CAMEO**—the **Creative Audio and Music Electronics Organization**. Members consist of companies who manufacture or distribute finished electronic music products. The purpose of



**Oberheim OB-1 programmable synthesizer.**

the luxury options. The **OB-1** is a completely programmable lead synthesizer. Parameters that are programmable include VCO tuning, waveform, VCF center frequency, VCF "Q", filter/keyboard tracking, envelopes, sync, noise, cross modulation, and volume. The system includes a

CCRMA's two track digital studio has been in operation since March 1976 .....

... Electronic music technology is slowly but surely making its way into the mainstream of musical technology design. The new **Beta** series of amplifiers by **Sunn** has integrated a "Q" circuit to allow accenting of selected frequency areas. The amplifiers are also stereo and 100 watts RMS. For information, contact Sunn Musical Equipment Company, Amburn Industrial Park, Tualatin, OR 97062 .....

... It seems like **George Duke** is going for the flash. On his new tour he will be using a device known (to whom I don't know) as the "**Dukey Stick**," described as a hand held light show. Other new toys include two transparent keyboards on wheels, a combination keyboard-synthesizer-guitar, and a plexiglass bub-



**Sunn Beta Series Amplifiers offer variable Q, and stereo capability at 100 watts RMS.**

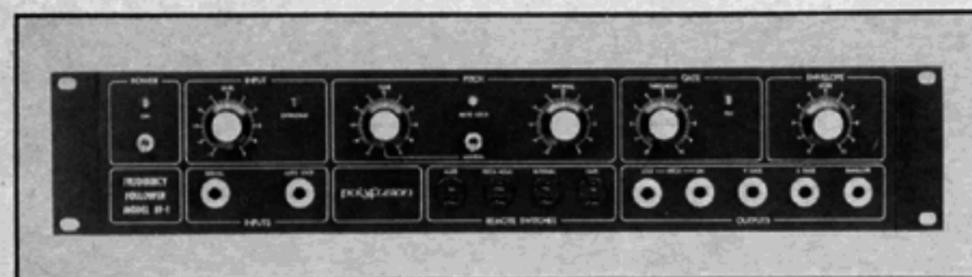

**Model FF-1 from Polyfusion features pitch to voltage conversion and envelope following.**

CAMEO is to expand the marketplace for member companies in various ways, including developing educational programs for salesmen and dealers in order to better expose the professional consumer to what specialized equipment is available. Long range goals include standardization of product. CAMEO headquarters are located at 180 North LaSalle St., Suite 3501, LaSalle Plaza, Chicago IL 60601. Executive director is David Schulman .....

... New from **Polyfusion** is the **FF-1 Frequency Follower**. The \$995.00 unit performs pitch to voltage conversion and envelope following .....

... Although **Oberheim** is known by some as the "Rolls Royce of synthesizers", this time they have come out with the economy item model including

switchable 12 or 24 db filter and an 8 patch memory. The \$1895.00 synthesizer is available from Oberheim Electronics, 1455 19th St., Santa Monica, CA 90404 .....

... **The Center for Computer Research in Music and Acoustics** has long been known for its innovations in applying computer technology to the field of music. **CCRMA** has now announced plans to build an all digital multi-track recording studio. Features are to include studio and location recording, overdubbing, editing, mixing, equalization, limiting-compressing-expanding, reverberation, delay, localization, pitch change, "etc." All functions will be in real time and fully automated. The number of tracks available at one time will range from 30 to 150.

ble containing an undisclosed surprise .....

... **The Cleveland Institute of Music** is offering courses in its **Department of Composition and Electronic Music**.

The Department focuses on the individual's interests and abilities; students' compositions are always played. Access to a studio is provided, and degrees offered are: BM, MM, DMA in Composition, and MM in Composition with Emphasis on Electronic Music. For more information, contact Dean **William Kurzban**, The Cleveland Institute of Music, 11021 East Boulevard, Cleveland, OH 44106 .....

... Computer music fans will be interested in the latest record release by **Tulstar Productions**, called **New Directions**. This two LP set, recorded live at the University of Tulsa in January 1978, features computer pieces by **Joseph Olive** (Bell Labs), **Jean-Claude Risset** (IRCAM), and **Emmanuel Ghent** (NY) among others. List price for the album is \$9.95. Copies may be ordered by writing to: New Directions, Tulstar Productions, Tulsa Studios, Drawer T, Admiral Station, Tulsa, OK 74112 .....

... **Rocktronics Entertainment Lighting** has announced the release of the **Stagemate Foot Control** for remote switching, flashing and dimming of stage lights by the performer. Special features include six on-off switches, and six momentary contact switches, two scuff wheels for dimming, and a blackout switch. The cost is \$275.00. For additional information, write Rocktronics Entertainment Lighting, 22 Wendell St, Cambridge, MA 02138 .....

... On March 18-19, **Sam Ash Music Stores** held an "**Electric Keyboard and Synthesizer Expo**" at the Traveler's Hotel in New York. Each participating manufacturer occupied a separate room, and those represented included Oberheim, Moog, Korg, Roland, Octave, as well as many other keyboard, and keyboard-related manufacturers. Rotating shows of many demonstrating artists took place in the hotel's auditorium throughout the expo. Early arrivals qualified for drawings of door prizes, among which were a Tapco keyboard

[Continued on page 8]

That's what Kerry Livgren of Kansas asked as he sat behind the keyboard of the new Korg polyphonic synthesizer. It didn't take long to transform Kerry from questioner to convert. Because after a few minutes of playing he found a lot more than the portamento.

Kerry discovered features he had never seen in any synthesizer. Like a totally polyphonic keyboard with each key triggering its own dynamic filter, envelope generator, and VCA. Polyphonic voltage-controlled sample and hold. Six different simultaneous modulations. A programmable wheel, joy stick and transient controllers. And a patch panel that performs musical miracles.

In fact, Kerry liked Korg so much he used the synthesizer on the Kansas album Point of Know Return. Here's what he had to say after the recording session. Take it Kerry.

### **"A New Ax Every Ten Seconds."**

"The Korg Professional Laboratory Systems synthesizer is in a class by itself. It sounds totally different from any synthesizer I've ever played. It's like having a new ax every ten seconds."

There are 10 Korg models of exceptional value, ranging from the Professional Laboratory Systems group to the new Micro Preset, which puts 315 instant voice combinations at your fingertips.

Whether you're looking for a preset, a polyphonic, or a dynamic portamento, you'll find a Korg synthesizer that meets your exacting requirements.



# **"Where's the portamento?"**



## **KORG**

Another superstar of sound from Unicord  
75 Frost Street, Westbury, N.Y. 11590  
Sold in Canada by Erikson Music Co., Montreal

**KORG** POLYPHONIC SYNTHESIZER



# Introducing the new Roland MicroComposer.

You've heard of word processing...and data processing. But have you heard of "music processing?"  
With the Roland MC-8 MicroComposer you can store...add to...delete from...re-

structure, and play back through a synthesizer as many as eight voice lines of your own musical composition. And you can do it instantly, as easily as pushing buttons on a ten-key adding machine. We call it music processing.  
But that's just the beginning. The list of additional possibilities fills an entire volume.

**Roland**  
The largest, most diversified line of electronic musical equipment in the world.

There's nothing else like the Roland MC-8. It is undoubtedly the ultimate innovation for recordists, musicians, composers and arrangers.



Let us tell you more about Roland's new MC-8 MicroComposer. Write today to Department 10-076, Roland Corp. U.S., 2401 Saybrook Avenue, Los Angeles, CA 90040.

[From page 6]  
mixer, a Giannini guitar, and a subscription to Synapse! . . . . .  
... **The 1550 Stringz 'n' Thingz** kit is a polyphonic keyboard kit recently released by **PAIA Electronics, Inc.**, 1020 West Wilshire Blvd., Oklahoma

City, OK 73116. The instrument performs piano, violin, and cello voicings, and many options are available including a microprocessor interface. The \$295.00 kit is available direct from PAIA . . . . .  
... **E $\mu$  systems** has released a **Voice Demo Kit** designed for



## The 1550 Stringz 'n' Things kit from PAIA.

experimenters and the OEM market. When completed, the board contains 2 VCO's, 1 VCF, 2 VCA's, and 2 transient generators. In the \$100.00 version, the user must supply various components, but E $\mu$  will provide a complete kit (all parts included) for \$250.00. Assembled and tested boards are available for \$450.00. Write to E $\mu$  Systems, 3046 Scott Bl., Santa Clara, CA 95050 . . . . .  
... A new guitar synthesizer has been released by **HEAR**, 1122 University Ave., Berkeley, CA 94702. The **Zetaphon** is a fully polyphonic synthesizer with guitar interface using additive synthesis for timbral generation.

Each of the system's two output channels has an envelope generator and controls to adjust the amplitude of the fundamental and the first five overtones. In addition, channel A has a pulse train output and channel B has a combination of the 8th, 10th, and 12th harmonics. The system features octave transposition, hexaphonic fuzz, portamento, envelope following, and automatic tuning. An eight switch foot pedal is also included with the \$4,000 unit . . . . .

... It looks as if **Todd Rundgren** will be the first major artist to release product for the home video market. **Visiondisc Corporation** has announced completion of the taping of an hour long Rundgren concert at **New York's Bottom Line**. The program was produced on broadcast quality videotape, with the sound recorded on 16 track and mixed personally by Rundgren. The late July release could be the beginning of something big . .

[Continued on page 50]

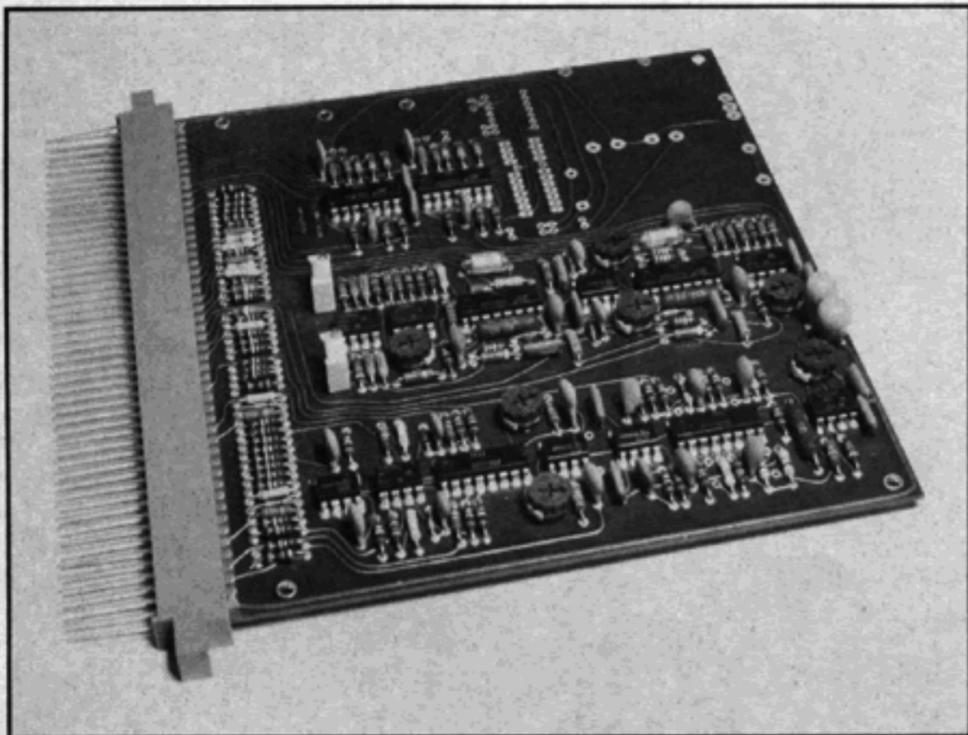

**E-mu's Voice Demo Kit for a complete synthesizer voice.**

# JUST THE FACTS

Synapse gives it to you straight. Just the facts. About synthesizers, the people who use them, design them, build and write for them. Where do musicians go for the complete scoop on electronic music? Synapse. The **International Electronic Music** magazine.

## Subscribe now!

**In the US:** One year/six issues: \$8.00. Two years/twelve issues: \$14.00. One year/six issues by First Class mail: \$14.00. **Outside the US:** One year/six issues by surface mail: \$10.00. Two years/twelve issues by surface mail: \$18.00. One year/six issues by Air Mail: \$20.00. **For the current issue of Synapse only:** Send \$1.50 plus 75¢ for First Class postage and handling. All orders must be prepaid in US funds. Send all orders to Synapse, Subscription Department 2:6, 2829 Hyans Street, Los Angeles, California 90026.



*Back issues: Get 'em while we got 'em!*

See coupon for complete details.

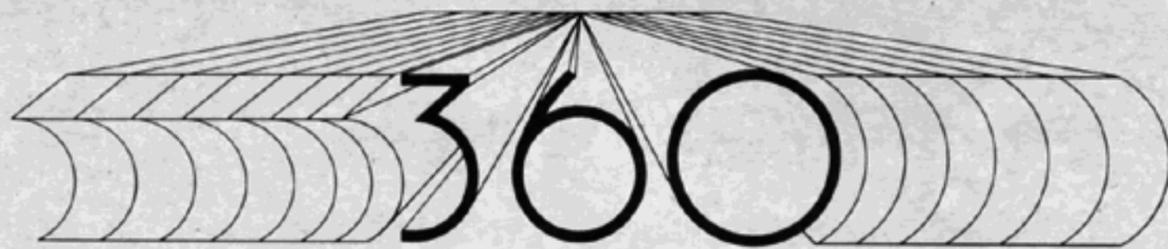

PRESENTS

# THE SYSTEM



## FEATURES

- 5 Octave Switching
- Parallel Harmony Footswitch
- Infinite Sustain
- Envelope Filtering
- Phasing and Flanging Effects
- Delayed Attacks/Backwards Guitar Effects
- Talk Box Effects
- Strings
- Brass
- Woodwinds
- Bass
- 2 VCO's
- 2 Envelope Generators
- 1 Low Frequency Oscillator
- 4-Mode Filter (LP, BP, HP, Notch)

## PERFORMANCE

- Works with most solid body guitars.

- Bass model works with fender basses (custom pickups available).
- Works with most popular synthesizers.
- Finest tracking system available. Follows pick or fingers.
- Has appeared on more records than any other guitar synthesizer.
- Easy to use. Patch books available.

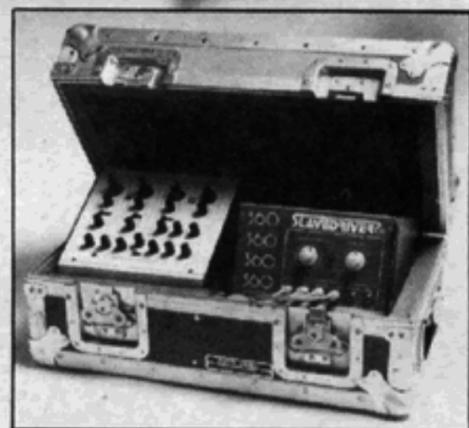

## THE SYSTEM 3490

- (Does not include Anvil Case)
- (Oberheim SEM \$695)
- (360 Slavedriver \$795)
- (Anvil Case—Ask your dealer)

360 P.O. Box 1804  
Santa Monica, Ca 90406  
SYSTEMS (213) 384-8447



## Hawkwind

### Quark, Strangeness, and Charm

Sire SRK 6047

*"Einstein was not a handsome fellow nobody ever called him Al he had a long moustache to pull on it was yellow I don't believe he ever had a girl one thing he missed out in his theory of time and space and relativity was something that made it very clear he was never gonna score like you or me he didn't know about quark, strangeness, and charm. . ."*

© 1977 Charisma Records LTD.

"I was delighted to see this group of 20th century barbarians in the midst of all their electronic junk, half masters of it, half in the power of it. I thought this was the first band which had, as it were, science fiction in its bones. Previously, bands like Pink Floyd had seen the ideas as 'wonderful'. Hawkwind accepted them as normal. That's what I liked and that's why I worked with them. They were a rock band, pure and simple, using the kind of facilities which attracted their imagination."

The album opens with a flash of cosmic static and machine hum. Tense, distorted human voices occasionally pierce through, suggesting communications in the control center of (you guessed it) a spaceship. The other instruments filter in gradually, driving a two-chord theme relentlessly home. Several layers of synthesized Morse code provide texture and rhythmic effect. Then Robert Calvert begins to sing. His voice comes over the ship's PA system, carefully enunciating the words, "I would've liked you to have been deep-frozen too. . .". The song, SPIRIT OF THE AGE, is sung from the viewpoint of a human clone returning to Earth after years in space, only to find his lady friend long dead because her father refused to sign the necessary forms and allow her to be frozen. Boy loses girl. The Calvert-clone makes some interesting observations about 20th (21st? 22nd?) century existence, noting that what we ordinarily consider 'personality defects' and 'faults' are at least unique traits, achingly absent from the lives of him and his test-tube brothers. This kind of thought and lyrical expression makes "QUARK" a successful sci-fi-rock album. This is not to say that Hawkwind is an altogether successful creative entity. Seen live at the Starwood several weeks ago, they were a disappointment. Most of the subtlety, humour, and synthesizer work were lost in a guitar-oriented attempt at rock 'excitement'. The sound was awful, but Hawkwind's audience seemed pretty oblivious, and enjoyed the show.

Anyway, the band has resurfaced with an entertaining new album. At worst (FABLE OF A FAILED RACE, HASSAN I SAHBA) they resemble a tolerable blend of other space-rock

bands. At best (SPIRIT OF THE AGE, QUARK, STRANGENESS AND CHARM, DAMNATION ALLEY), they are Star Trek, with balls.

—Andy Capraro



## Michael Hoenig

### Departure From the Northern Wasteland

Warner Brothers BSK 3152

Sequencers have become a staple of what might be called "popular" electronic music. People hardly bat an eyelash after hearing the same melodic and rhythmic figure for ten to sixty minutes. Maybe listeners have been conditioned by years and years of pop rhythm tracks. In any event, this repetitive genre—where the rhythm tracks become the main tracks—will have to develop beyond its rudimentary stages or die from stasis.

At this time, progress takes the form of Hoenig's Departure From the Northern Wasteland. The album does not start with a bass sequence, or any sequence for that matter. This does not insure a good album, but it allows the sequencer to be part of the music's growth. The first cut, bearing the album's title, lasts the entire first side. Growing out of sustained tones and aptly "northern" voices is the sequencer that we have all learned to expect. But something is different—the sequencer rises and falls, and further rhythmical divisions permute the sequence and its melodies. Finally, all stop with a grand chord and then the process starts

over, muted but half way to its climax. From here it is introspective territory—the feeling of ending.

Side two begins with "Hanging Garden Transfer," a piece that highlights two other stylistic developments present on this disc—harmonic and melodic structuring. Drama, a sometimes lost consideration, also finds a space on this cut.

"Voices of Where" is perhaps the most interesting cut, but also the least commercial. Over the background of a wafting drone, several tape loops weave slow continuously changing melodic clouds. Heavy metal shimmerings announce the "voices", once again on tape loops, interacting rhythmically over barely perceptible synthesizer effects. This piece represents a different, although not new, approach to rhythmical structuring and the use of voice as a compositional element.

"Sun and Moon" comes on with a fanfare and quickly becomes a changing sequencer bass line with a vaguely exotic, double reed sounding melody. Then a more rhythmic stance is taken as a second sequence interacts with the first. Built over the top is a highly orchestrated "tune" that has its origins in folk music. The four and a quarter minute piece is very bright sounding and accessible. Listen for it on FM.

—Doug Lynner



## Kraftwerk

### The Man-Machine

Capitol SW-11728

*-Son, been wondering about this, ah, "screwing in" you kids are doing. This matter of shooting electricity into the head, ha-ha?*

# THE GUITAR CORD USED BY OVER 100 OF THE WORLD'S TOP BANDS:

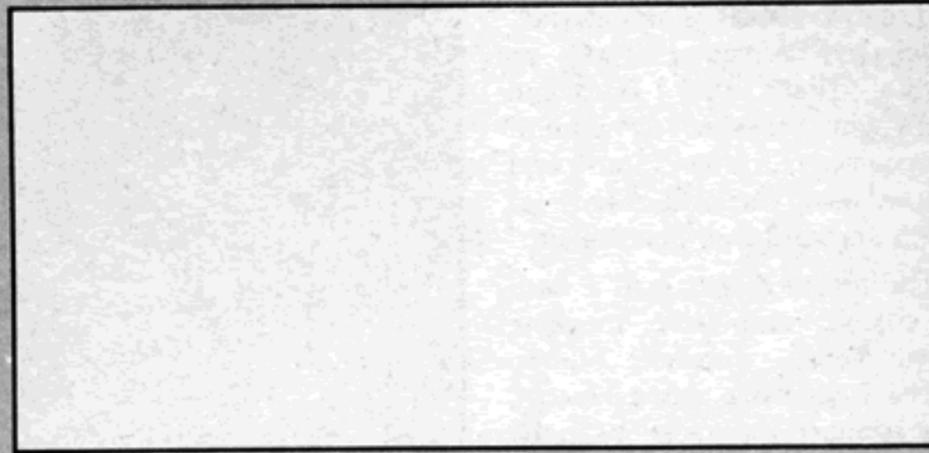

(none)

## The Schaffer-Vega Diversity System

Steve Stills, Heart, Kiss, Foreigner, Foghat, Steve Miller, Derringer, Electric Light Orchestra, America, Commodores, The Beachboys, Earth Wind & Fire, Thin Lizzy, Mahogany Rush, Peter Frampton, AC/DC, The Fifth Dimension, Frank Zappa, Mandre', Chic, Johnny Guitar Watson, Rufus, John McLaughlin, Melanie, LTD, Pat Travers, Aerosmith, Heatwave, Peter Gabriel, Nektar, Bob Welch, Elvin Bishop, Kansas.

**Of all nationally known bands who've gone wireless, every one of them has done it with SVDS—EVERY ONE OF THEM.**

-Waves, pop. Not just raw electricity. That's fer drips!

-Yes, ah waves. "Keying waves", right? Ha-hah. Uh, tell me, son, what's it like? You know I've been something of a dooper all m'life, a-and—

-Oh pop. Cripes. It isn't like dope at all!

-Listen Tyrone, you don't know how dangerous that stuff is. Suppose someday you just plug in and go away and never come back? Eh?

-Ho, ho! Don't I wish! What do you think every electrofreak dreams about? You're such an old fuddyduddy! A-and who sez it's a dream, huh? M-maybe it exists. Maybe there is a Machine to take us away, take us completely, suck us out through the electrodes out of the skull 'n' into the Machine and live there forever with all the other souls it's got stored in there. It could decide who it would suck out, a-and when. Dope never gave you immortality. You hadda come back, every time, into a dying hunk of smelly meat! But We can live forever, in a clean, honest,

purified Electroworld.

-**Thomas Pynchon** "Gravity's Rainbow," p. 698-99 © 1973  
Viking Press

This album is a classic example of power and how to abuse it. Since the world-wide incursion of this band a few years back, Kraftwerk's two masterminds, Hutter and Schneider, have been consistently adding exponents upon exponents to their "human-dynamo image projector". This is a case of taking a not particularly inventive or original idea and expanding its impact by making it increasingly disconcerting.

Indeed the notion of "Man-Machine" has been nurtured by various fertile scientific and artistic minds throughout the last hundred years. Near the turn of the century, for example, Henry Adams wrote a semi-autobiography entitled "The Education of Henry Adams", a book devoted to the idea that civilisation was on the verge of an enormous change, a change far beyond the precepts acceptable for that time.

The essence of the book can be found in the chapter, "The Virgin and the Dynamo", inspired by Adams' visit to the Chicago World's Fair of 1896. In the science exposition hall Adams witnessed a great number of electrically powered inventions that made him question what inspired man to go in this new direction (as opposed to the spark that inspired, for example, the great cathedrals of Cologne or Notre Dame). Adams attributed the inspiration to mental energy common to all true artists, the presence of the Virgin, the Muse. With the fragmentation of the church, man lost the presence of the Virgin/Muse and simultaneously the one figure that had kept science and art in close proximity.

Adams felt however that a new homogeneity was being realised in the form of a new Virgin or electrical Muse. Because she is a creation of, rather than a participator in, man's post-Reformation progress, she stands amid man's lapses into folly, rather than at a distance.

Thomas Pynchon later developed this idea in his book "V", wherein the innocent Victorian heroine, Victoria Wren, gradually evolves into a literal dynamo, developing ultimately into a fascist robot, functioning on sensations that echo sensations. Pynchon's third novel, "Gravity's Rainbow", took the idea a step further, using the V-2 rockets that fell on London in the latter days of World War 2 as symbols for what Arthur Koestler termed, "the end of Renaissance Man".

Pynchon wove a very complex mythology of paranoia as means of survival in a world that has not been the same since the Reformation. Pynchon's final projection of Man's Fate stretches far into the future, to the Rocket City, controlled by cold, sexless little "Rocketmenschen".

At this point enter Ralf und Florian in their most recent incarnation of Cyborg City. The opening Sci-Fi strains of "The Robots" winds down into a mechano-disco beat (doubtlessly the work of Leonard Jackson, Norman

You'll read lots of claims about the advantages of wireless instrument & microphone systems. The advantages are real. But over 100 major groups agree that colorless sound & absolute reliability come only with SVDS.

100 major bands have gone wireless with the Schaffer-Vega Diversity System. With over 12,000 performance hours, not a note has been missed. Our guarantee against embarrassment is so effective that SVDS has received over a dozen album credits from groups who've stayed SVDS wireless for studio recordings & live network broadcasts.



**Unchained Melodies With No Strings Attached** We've got a whole lot of great moves for you. **With SVDS you get:**

- Guaranteed 500' (minimum) performing range.
  - No interference from *any* source.
  - Two receivers & a true computer mean no dropouts.
- SVDS technology is proven; SVDS users don't take chances in front of 30,000 viewers. It's \$3,340 for the X-10 Instrument System; \$3,000 for our SV1122 hand held mic.

### **The Ken Schaffer Group: Where Time & Space Meet**

*We're rock's top source for High Technology.*

*America's Primary Source for EVENTIDE Digital Delay, Harmonizers & effects.*

*The first stop for fully designed, integrated custom special effects systems.*

*Now Available: The Eventide Harmonizer Offboard remote footswitch/instrument interface for musical interval selection.*

*We specialize in the Impossible. And we perform it for nearly every major band.*

*Give us a call. Or drop \$2.00 & we'll send you some of the most interesting literature in Musical Electronics.*

**If You Think You're Serious About Wireless, Delay or Special Effects,  
and Don't Speak To Us—You're Not Serious.**



## **The Ken Schaffer Group, Inc.**

10 East 49th Street New York NY 10019 (212) 371-2335

Whitfield's house engineer, who is credited on the album) that pops off into crystal diode beats and blips, interspersed with a vocoded voice announcing, "Ve ahre zuh R-r-ro-bahts. . ." Somebody deserves a pie in the face for this imminently baggy-pants, disco-vaudeville one-liner that sounds like another Pynchonesque nightmare of Cuddles Sakol lost in the Frankfurt Metro.

Onward to "Spacelab" and "Metropolis". The former purveys the digitally sequenced beat that made Donna Summer famous, augmented with light Moog-chart in the background, as the song segues into the latter. Strong shades of Fritz Lang. . . "The new module speeds to the rescue of the stranded intergalactic travellers, while ten light years away on earth, a man in a grey trenchcoat standing in a Bonn railway station pulls out what appears to be a cigarette lighter. . ."

"The Model" on side two is another back-beat oriented comment on the "Der Stern" mentality

that brought forth "Showroom Dummies". However, "Neon Lights", with its build-up of layers in typical Kraftwerk assaults of quavering, phosphorescent voltage, seems to be saying that maybe the New Deutschland is not so bad either.

The final cut, "The Man-Machine", is minimalistic, metered prose, the quality of which is both the crux of, and the problem with, the image that Schneider and Hutter have created for themselves. It is that of an intelligence eagerly clamoring to get immersed into the clean, silent Electroworld, where nothing bad can happen because all the electrical charges in the universe have become both like and equidistant.

Kraftwerk approach the desirability of this state with little or no apprehension: they already belong to the Rocket City. The question that they pose is that of how fast we are going there. The group's early image of clean cut physics majors has been replaced on the new album with propaganda poster graphics, predom-

inantly red. The guys wear matching red shirts, black ties, pomade hair, and make-up, looking like chorus boys from some hideous, never-to-be-released UFA musical directed by Leni Riefenstahl. It is this blithe advocacy of merging human intelligence with forces that man has yet to fully know or control that chills the mind.

The electromagnetic spectrum's possibilities were just becoming apparent when Henry Adams wrote "The Virgin and the Dynamo". The frightening portrait that Kraftwerk create, intentionally or not, is that of unbridled technology, a world where swarms of enthusiastic engineers compete for the greatest amount of symbiosis between humans and machines, a world however bereft of the saving graces of language and art. What appears to be sought is a homogeneity that will erase all conflict, and thus all history both natural and anthropological: The Rocket City. Their philosophy has all the romance of entropy, yet it cleverly, profi-

ciently and attractively makes the Electroworld a desirable place to be.

*"What if there is no vacuum? Or if there is—what if They're using it on you? What if They find it convenient to preach an island of life surrounded by a void? Not just Earth in space, but your own individual life in time? What if it's in Their interest to have you believing that?"*

*"He won't bother us for a while", They tell each other. "I just put him on the Dark Dream." They drink together, shoot very very synthetic drugs into skin or blood, run incredible electronic waveforms into Their skulls, directly into the brainstem, and backhand each other, playfully, with openmouth laugh—you know, don't you is in those ageless eyes. . . They speak of taking So-and-So and "putting him on the Dream". They use the phrase for each other too, in sterile tenderness, when bad news is passed, at the annual Roasts, when the endless mindgaming catches a colleague unprepared—"Boy, did we put him on the*

# It's quiet and voltage controlled.



If you've had to put up with noisy flangers and phasers and are bored with the standard back-and-forth sweep they offer, then hookup your synthesizer, axe, bass, microphone, or keyboard to the most popular and versatile sound modifier available, the A/DA FLANGER.

Preferred by studio musicians and engineers over digital rack-mount units for performance, dependability and quietness, the A/DA FLANGER's sophisticated circuitry eliminates the "characteristic" background noise found in all other analog flangers. And for extremely low noise applications such as recording, the THRESHOLD control may be adjusted to eliminate any minute amount of residual noise without impeding or squelching the original signal.

The only flanger capable of true voltage controlled delay, the A/DA FLANGER may be triggered, swept, tuned to a resonance frequency or modulated with your synthesizer control voltage for an infinite selection of sound effects. Also, you may use our accessory foot pedal, CONTROL PEDAL A, to control the delay time. Other unique features include an EVEN/ODD HARMONICS selector, that virtually doubles the range of sound effects, automatic sweep that may be set between a fast 0.1 second vibrato to a very slow 25 second sweep cycle.

Housed in a rugged sand-cast aluminum case with recessed controls, the A/DA FLANGER has brought flanging, phasing, vibrato, rotating speaker effects, Doppler effects and notch filtering to their ultimate refinement. The A/DA FLANGER, it's quiet and voltage controlled!

Please call or write us for further information and the name of the dealer nearest you.

**ANALOG/DIGITAL ASSOCIATES**  
2316 Fourth St., Berkeley, CA. 94710  
(415) 548-1311



*Dream.* "You know, don't you?"

—**Thomas Pynchon** "Gravity's  
Rainbow," p. 698-99 ©1973  
Viking Press

—**Franc Gavin**



## Eela Craig Hats of Glass

**Vertigo 6360638 (Import)**

With the title "Hats of Glass", Eela Craig presumably make reference to the de-rigueur sci-fi interstellar helmet spawned by Jules Verne for the conventional space and undersea adventurer. Eela Craig (so clever, these name bands) take the listener through your basic gamut of intergalactic and intrapsychic voyages.

Keyboards tend to dominate the flow of the LP, which is smooth and liquescent. The material ranges from the cover (Chris de Burgh's "A Spaceman Came Traveling") to the group-authored title track. It is within the lyrical content of this last piece that the three member group reveals, if not altogether successfully, just what was intended with this above average progressive effort.

It's not that Eela Craig have failed. Not at all. It's just that, on the first listen, lyrics such as, "That summer night when quiet Gulliver came/ Lost in a world where no one knew his name/ And we found him with a woman/ And we took his life" tend to strike one as rather odd. They have that obtuse Zen-murder quality, just enough to appeal to a certain lunatic fringe.

The rest of the lyrics have a certain Asimov cum L. Ron Hubbard consistency about them. You've heard it all before. A group of brilliant and self-conscious telekinetics build a "Space Ark", and proceed to blithely

blast off to new territory and a new life. In transit however, they discover that the techno-evolutionary path ain't all Beer 'n Skittles. Comes the anguish of the New Gods, or "Von Daniken meets the Harrad Experiment meets Getting in Tune With Your Alpha Waves".

Fortunately, all this heaviness comes across more like a delicate hybrid between Tangerine Dream, Nice, and Genesis mit lotsa Schlagers (they are from Salzburg). Fritz Reidelberger and Will Orthofer's vocals and harmonies have a light, grainy texture to them, highly reminiscent of Lee Jackson's salad days in the Nice. The AKG's do their chart work well, falling down over the ornate melody lines like sheets of rain on cathedral windows. They soon predominate the mood and ultimately become the mood. Finally, the flutes and glass-figurine guitar shapes counterbalance the electronic partitions as would the right objet d'art on some empty pedestal.

This effort draws heavily from time-honored sources, but it is nonetheless a pleasant, intellectual confection; and although it has been done before, it was not usually this well.

—**Franc Gavin**



## Steve Hackett Please Don't Touch

**Chrysalis Chr 1176**

'Please Don't Touch', Steve Hackett's first solo attempt since his departure from Genesis in 1977, demonstrates some of the dilemmas which confront a solo artist making an album. The results are sometimes a compromise, sometimes a triumph, but always interesting.

Sequential Circuits Introduces:

# the prophet

## The Industry's First Completely Programmable Polyphonic Synthesizer

When Sequential Circuits introduces a synthesizer, you can be sure it utilizes the most advanced technology. . . . . state-of-the-art technology that makes readily available the most asked for features musicians have been demanding for years.



### the prophet

has 5 complete voices, with 2 oscillators per voice. Individual oscillator tuning? We think you have better things to do with your time. The Prophet's powerful internal computer automatically handles all tuning. The same computer lets you create and record 40 different patches and recall any at the simple touch of a button.

More? A 5-octave keyboard. Pitch and Modulation wheels. Small size (37" x 16" x 4½"), ideal for stacking with other keyboards. Memory power back up with a 10 year life.

The Prophet provides unparalleled ease of use while retaining the sophistication required by the most demanding synthesists.

Prove it to yourself. Ask your local dealer or write us for further information.

**SEQUENTIAL CIRCUITS INC**

1172G Aster Avenue, Sunnyvale, CA 94086 (408) 296-3116

# serge modular

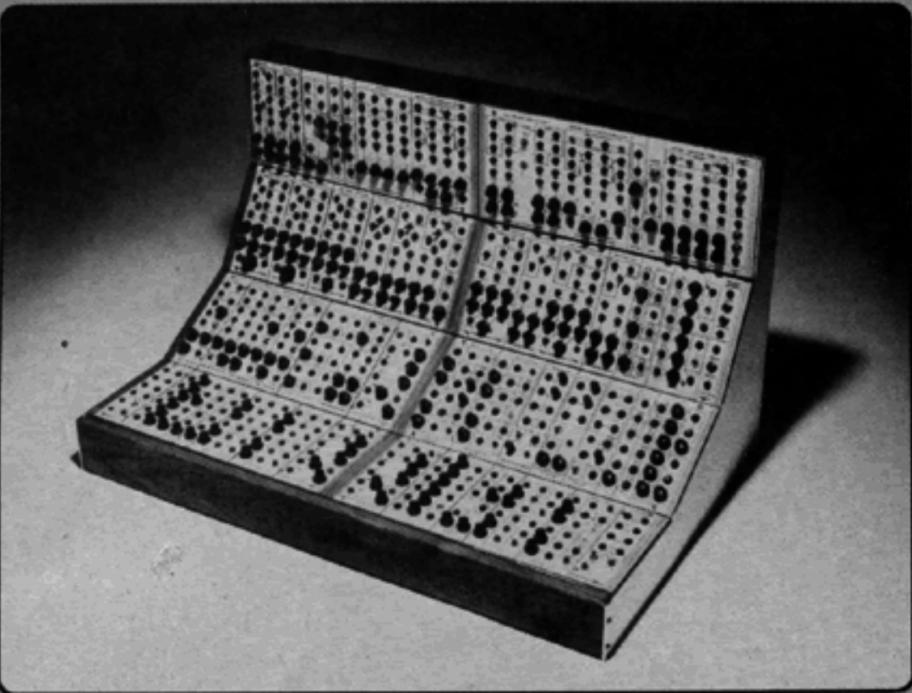

PHOTO BY BILL MATTHIAS

## music systems

We'd like you to know about **Serge Modular**. We make what may be the most precise and versatile synthesizer system in use today. The Serge Modular is available either fully assembled or in money saving kit form. We made it modular, to assure that a musician (or video or computer artist, for that matter) can put modules together to fit his or her specific needs, and also to make room for future expansion of a Serge System. We adhere to industry standards such as 1 Volt per Octave VC inputs etc. to allow easy interface between Serge Systems and other synthesizers. We made it as versatile as we could within the state of the art, because we wanted to expand the possibilities of synthesis, not to limit our equipment to a few pre-patched effects. We made it innovative, because our pursuit of the highest quality allied to an affordable price made it hard not to be innovative, and because we are basically research rather than commercially oriented.

**A few specifics about our hardware:** We make the stables oscillators, guaranteed over a temperature range of 40 to 100°F. And the trackingest. Our precision VCOs track within a cycle over the entire pitch range. Our VCA's and Panners feature over 80 dbS S/N and better than 60 dbS control rejection. Whether stereo, quad, penta or octo-phonic, our panners adhere to the equal power law for the smoothest and most accurate spatial location. Many of our modules are patch-programmable. This means that they can be patched to perform functions which in traditional systems would require sep-

arate costly modules. For example, our Dual Universal Slope Generator can be patched to work as envelope followers, log-linear saw, triangle and timing-pulse VCO's or LFO's, accurate VC portamento, VC pulse delays, envelope generators, and VC sub-harmonic generators. We use industrial quality components only, to ensure 100% reliable performance. **When we ship an assembled system, it is fully burned in, calibrated and guaranteed 2 years, parts and labor.** When we ship a kit, even an inexperienced kit builder is assured success, because we ship all pc boards fully assembled, tested and calibrated.

We wish we could tell you more about **Serge Modular**. Being innovative, and not necessarily falling under run of the mill categories, our modules may cause some consternation. Wherever possible, we'll gladly arrange a live demonstration in your neighborhood. (We find our customers are our best sales people.) If that's not possible, we'll gladly answer your questions by return mail. Meanwhile, you may wish to order a packet of information concerning Serge Modular, consisting of a variety of new product announcements, our catalog & price list, and a short Instruction Manual. All that we ask of you is to send us \$2.00 for the packet, and your name and address to:

**Serge Modular  
Music Systems**  
1107½ N. Western Avenue  
Hollywood, CA. 90029  
(213) 461-7987

For openers, as fine a guitarist as Steve Hackett is, his playing has seldom been characterized by the kind of flashiness which rivets the attention regardless of context. Hackett has usually relied on tastiness, which in itself is of the highest value, but which in turn depends on strong writing to give it meaning. As a co-writer and contributing player in Genesis, his work was cut out for him. Declining the more prominent role of other powerhouse guitar players, Steve's greatest contributions lay in his mastery of moods and textures; and his playing concept was part of Genesis' total sound. The question arises whether this role of textural technician is a viable concept by itself. This is what 'Please Don't Touch' tries to achieve.

A quick look at Hackett's equipment list will be enough to assure anyone that his album contains many different sounds. Mellotron is included, as well as acoustic and electric guitars, guitar synthesizer, octave dividers, phasers, wind chimes, sleigh bells, and "... anything else that I could lay my hands on at the time!" All of these instruments and effects are used well to create many different moods.

"Land of a Thousand Autumns," "Please Don't Touch," and "The Voice of Necam," three instrumental pieces on side II, form a trilogy of material whose development and primary motivating force derives from textural changes. Thickening electronic sounds contrast sharply with acoustic and more "natural" ones. The textural changes between a full band playing, as opposed to a solo instrument, are present. The music doesn't change much however—just the means of producing it. There are of course, many subtleties to these changes, and you really have to hear them to appreciate the variety of sounds; but with all this, there is still a melodic element missing, a one dimensional quality to the writing; and except for a few places, most of what is played is harmonically very simple, so that textures are really the most interesting aspect.

The end result of this gives one the ironic feeling that Hackett, although responsible for all the writing and much of the playing

on 'Please Don't Touch,' doesn't star on his own solo album. His role still remains that of contributor, only in this case it's main contributor. Doubtless Genesis fans will enjoy this aspect of the album, because after all this is what Hackett has done so well in the past. More interesting to this writer however, are the ways in which Steve solved his other dilemma—that of a solo artist who doesn't sing—and his various solutions bring some moments on the album which are seldom attained on any disc.

"Carry On Up The Vicarage," a tribute to Agatha Christie, actually features Hackett on vocals, although the voice sounds far from human because of how it was recorded. Using tape techniques available in the studio, Steve modified his voice so that what comes across is two voices, one very high and one very low, creating the strange atmosphere which the lyrics demand. This piece also opens with a music box playing over background tape loops, also recorded at low speed; and these fade into an eerie rendition of a well-known Christmas carol. Very effective.

Aside from using his own voice to put his tunes across, Hackett has made three excellent and very original choices. The first cut, "Narnia", features Steve Walsh, lead singer from Kansas, on vocals. His strong lyrical rock style lends itself perfectly to this song. His presence is likewise a charismatic addition to "Racing in A", a cut which requires this kind of free yet forceful approach. In direct contrast to this, but completely in keeping with the precepts of the music, Hackett has chosen Richie Havens to sing on "How Can I", and "Icarus Ascending". Havens has never sounded better. The mournful quality of his voice makes these songs especially haunting even when the lyrics are not completely convincing. But the killer on this album is the one featuring Randy Crawford called "Hoping Love Will Last". Here, the writing, lyrics, textures, and vocalist all combine in a work so moving as to wrench the heart out of almost any listener. If you survive the first listening of this one, you will probably want to play it again.

All in all, 'Please Don't Touch' has much to recommend it. It is

# Rick Coupland has just Re-Invented the Synthesizer.

Every performer knows exactly what's wrong with keyboard synthesizers: they're not really **performance** instruments.

The Coupland Digital Synthesizer is designed to be played. Not tweaked and fiddled with. The computer does all that, instantly. The composer can spend his time composing. The performer can spend his time performing.

But that's just technical stuff. The important difference is the sounds. You don't just select or modify sounds. You **design** sounds. Your sounds, not somebody else's. You create and perform in your own style.

The Coupland Digital Synthesizer can create virtually any musical sound ever heard on earth. And the sounds that have never been heard. Really.

Maybe you'll never believe all this. until you hear it. Then you'll believe.

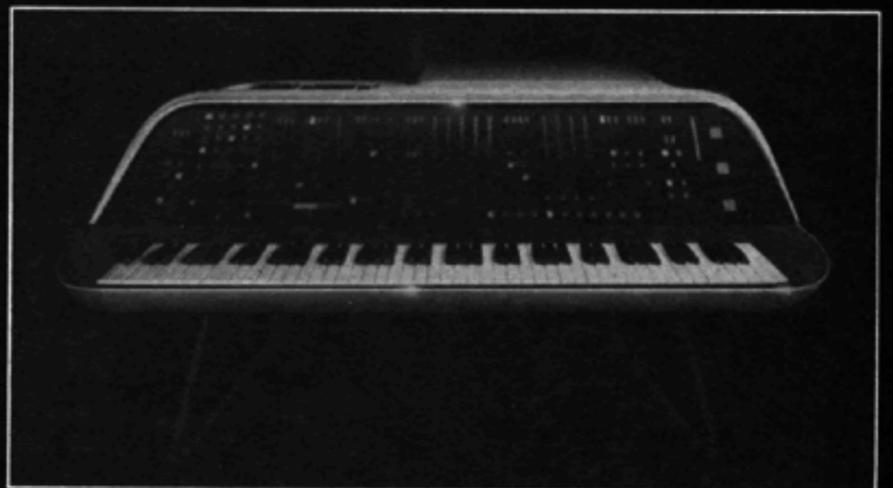

Coupland Digital Synthesizer, Model One  
where the next new sounds will come from.

**Coupland**

DIGITAL SYNTHESIZER

Micor Inc. • Audio Products Division • P.O. Box 20885 • Phoenix, Arizona 85036  
(602) 273-4381

**Rick Coupland:** genius.

musician/composer,  
computer programmer, inventor,  
and well-dressed-man-about-town.

# POLYPHONY



**POLYPHONY:** *po·lyph·o·ny, po·lif'ō·nē*

(Gr. ployphōnia) Consisting of or having many voices or sounds. (Mus.) having two or more voices or parts, each with an independent melody, but all harmonizing. A publication for electronic music enthusiasts, with an accent upon the design, repair, performance and understanding of electronic musical equipment and accessories. (published quarterly)

- Written by people who understand how it all works
- Technical information on how it works, how to modify it, and how to fix it. (Not to mention what to do with it once it's all together)
- It's only \$4.00 a year to have it delivered right to your very own mailbox. (\$5.00 a year/ Canada & Mexico; \$6.00 international)

## POLYPHONY

PO Box 20305  
Oklahoma City, OK 73156

- Enter my one year (4 issues) subscription
- Tell me more..... send a sample issue; \$1.00 enclosed.

Name \_\_\_\_\_

Address \_\_\_\_\_

City \_\_\_\_\_

State \_\_\_\_\_ Zip \_\_\_\_\_

an attempt at something new, and that in itself makes it worth a listen. Hackett has also brought some excellent musicians together to support him. They are: himself, Dave Lebolt, John Acock and John Hackett on keyboards; Chester Thompson and Phil Ehart on drums; Tom Fowler on bass. Tasty additions include Graham Smith on violin, and Hugh Malloy on cello.

—Melodie Bryant



## Iowa Ear Music

Corn Pride Records

This is an anthology of thirty-one pieces of free form music, co-ordinated predominantly by Will Parsons and Michael Lyttle, which are cut, segued, and superimposed upon each other with varying degrees of success.

The performances are split into two sides (oddly enough!): Sidechop, "Documenting Eighteen Formerly Secret Performances," and Sideflow, "Mandala Life-sample;" however, the Sidechop flows as well as, or better than the Sideflow. "Pete's Beet" goes into "Anton's Chickenyard," into "Basschurn," into "Degroot No. 13," superimposed with Unseen Wall, fading into "The World's Most Impossible Silence" (eighteen seconds of just that) in just four and a half minutes. The result is that (besides forcing one's eyes to remain glued to the extensive jacket credits to keep track of which of the pieces is playing) the record takes on the appearance of a long work in which each track is only an element.

Musically, the selections run the gamut from blues and pseudo-serialism (pan-idiomatic improvisation), to hokey synthesizer sequences and spacey electronic sounds; but as the jacket says,

"Resemblances to all music, living or dead, are purely matters of taste." The pieces on this album are mostly excerpts from extended improvisations, with little texture change or musical development. Consequently, each piece in itself would get boring after a few minutes; however, few of them last that long, and they are interesting simply because they are so short. The texture changes and musical development are accomplished by the mixing of the pieces into each other.

Eight of the pieces come from the "Four Room Session" of March '73. According to the notes, this session involved players improvising in four different studios, connected only by mikes and headphones, changing combinations every fifteen minutes, and involving approximately thirty musicians altogether in the four hour session. Those tapes were then edited and mixed into the excerpts that appear here.

Another one of the pieces, entitled "Falsestart, Falsestart, Falsestart Etc.," is an excerpt from a rehearsal of the Center for New Music. The pianist plays a note, evidently not in the manner that was intended, because he stops and yells "Falsestart," and starts over only to make another falsestart. This happens several times in a row, and once again does not play itself out because of its length and its accompaniment by other pieces.

Sideflow, on the other hand, contains fewer pieces (ten plus two reprises, as opposed to nineteen on Sidechop), which are connected by "MayaMusic" and "Shiva Drone," a violin dominated drone, and a Moog modular sequence respectively. These two continuous pieces fade in and out of the rest of the music on the side, and provide recurring motifs. However, the majority of this side is not as captivating as Sidechop. There are two parts though, that are high points of the album: "With the Sun Inside, Maturity," which sounds like Miles Davis' "In a Silent Way," but takes the concept farther into spaceland; also the end of the side, "Lonely Woman, Ornett Coleman," a haunting processed trombone solo, with a Moog Sequencer background, which materializes out of a montage of tape pieces done on various

Moog, EMS, and Buchla synthesizers. "Lonely Woman" then fades into a very low volume reprise of "MayaMusic," and "Shiva Drone," which recede into the distance and the leadout groove of the disc. Very nice.

Also, dig the pig in the Corn Pride record Label! Copies of this album are available for \$5.50 (including postage) from Corn Pride records, PO Box 2655, La Jolla, CA 92037. I guess you can't be an Iowa Ear forever.

—Danny Sofer

## NEW RELEASES

### Steve Hillage

Green

Virgin V2098

### Bo Hansson

Music Inspired by Watership Down

Sire SRK 6044

### J. Jasmine

My New Music

ARC PO Box 5051

Berkeley, CA 94705

### Ralph MacDonald

The Path

Merlin 2210

### Be-Bop Deluxe

Drastic Plastic

Harvest SW-11750

### Bulent Arel

& Daria Semegen

Electronic Music for Dance

Finnadar SR 9020

### Todd Rundgren

Hermit of Mink Hollow

Bearsville Records

BRK 6981

### David Behrman

Figure in a Clearing

Lovely Music, Ltd.

LML 1041

463 West St.

NYC 10014

### "Blue" Gene Tyranny

Out of the Blue

Lovely Music, Ltd.

LML 1061

### Peter Gordon

Star Jaws

Lovely Music, Ltd.

LML 1031

### Meredith Monk

Key

Lovely Music, Ltd.

LML 1051

### Robert Ashley

Private Parts

Lovely Music, Ltd.

LML 1001

### Jon Hassell

Vernal Equinox

Lovely Music, Ltd.

LML 1021

### Gregory Allen Fitzpatrick

Bildcirkus

SAM-Distribution

Musik AB

Fack 185 00 Waxholm

Sweden

## Performance:

# Sixth Annual Electronic Explorations

5/26/78 Birmingham High School, Van Nuys, California

It was a night of signs. First, the school marquee beaming "Electric Concert". Second, and by far my favorite, was "Ritvo for Pres." Third was a series of concert posters with arrows guiding one through a huddle of buildings named A, B, C, and D. Walking into the auditorium I saw

the fourth sign—total chaos.

I am endlessly confused, amused, and frustrated that so many electronic music concerts are plagued with technical disasters. It was not idle paranoia that had almost every composer walking to the stage shortly after their piece began. The problems

# How did Bob Welch deliver on his famous French Kiss? With both hands.



With the Ampeg Patch 2000, Bob can play the guitar with just one hand—so the other's free to play the synthesizer. That's not possible with any other synthesizing system now on the market.

That also means Bob can create glides and other electronic effects that wouldn't be possible with any other instrument. So it's no wonder the Patch was one of Bob's favorite accompanists on his fabulous French Kiss album.\*

It's going to be one of your favorites, too. To find out more—and to find the dealer nearest you—write Ampeg, P.O. Box 2232, Dept. V, Ft. Wayne, IN. 46801.

Bob Welch is playing the Patch 2000 and so's Bob's old group, Fleetwood Mac.

Why? Because the Patch lets today's stars tackle today's sounds with both hands. And it can do the same for the stars of tomorrow.

\*Capitol EMI, ST11663, C. 1977, Capitol Records, Inc.



Visit us at NAMM at Booth 5030.

MAY/JUNE 1978 19

# TRADE IN YOUR MELLOTRON

Old Mellotrons are needed for factory rebuilding. To fill the demand, we are offering a liberal trade-in allowance on your old model towards the purchase of a new Mellotron 400 SM or Mellotron Mark V. Or, if you prefer, have your old Mellotron factory converted to new 400 SM specifications. Converted Mellotrons incorporate all of the improvements found on new 400 SM models and are covered by a new warranty. Find out what your old Mellotron is worth. Call or write . . .



**MELLOTRON®**

A DIVISION OF  **SOUND SALES INC.** Sherman, Conn. 06784  
(203) 354-9395

# PERFORMANCE

reached such proportions that composer Steven Bilow received his first public performance through only one of the intended four speakers. Earlier in the program, Barry Schrader's "The Gathering of the Kings; the Hunting of the Bulls" was distinguished by starting at double tape speed. All was made worse by the fact that the program material consisted of spoken voices. The Munchkin image this mistake created was not easily dismissed. At the risk of belaboring the point, it is the responsibility of the concert producers to insure adequate performances of the music. If experience is lacking, practice the set-up. Anything short of this equals disregard for the audience, composers, performers and your own efforts. Enough said.

The evening opened with "You Just Kill Me", by concert producer Peter Grenader. The composer described the piece as a "linear becoming of a tonal element from a more pantonal, percussive series of timbrally oriented sound events." This was very clearly true. Perhaps too much so, as the piece moved predictably from point to point. The sounds were all pleasant but lacked purpose within this context. A larger challenge or a more detailed solution would likely bear more fruit from this composer.

"Theme and Variations," by Arthur Kreiger, was not only composed at the Columbia-Princeton Electronic Music Center, but composed in its image. And very skillfully to be sure. The timbral qualities were very thick and defined; the rhythms like an epileptic machine gunner; and the pitches right out of another decade. Enjoyable nostalgia.

Film maker Richard Baily presented "Night Waves", an interesting combination of his animation and compositional talents. The visual images were vividly colored, and each type of image was aligned to a sonic theme or texture. It was unfortunate that the sound was distorted by the projector and mixed with its mechanical racket, but nevertheless, a success it was. More attention could have been paid to the development of the basic structural elements, however.

As mentioned earlier, Steven Bilow's, "Journeys in a Dicotyledon", was maimed by technical

ineptitude on the concert producers' part. Even so, an emotional juxtaposition in the structure was held intact. By foregoing opening fanfares and merely processing the sound of moving water, Bilow managed to provide an uplifting and almost giddy sense of security. In contrast, the following electronically generated sounds reminded one that there is a transient quality to almost every state. Returning to the water did complete a classic pattern but did nothing with the tensions that had been created.

Barry Schrader's "The Gathering of the Kings; the Hunting of the Bulls", and "The Temple of Poseidon; The Dance of the Gods", each started with spoken voice and then had an instrumental section. Exception can be, and has been, taken with Schrader's "style", but his talent for composing effective dynamic change is imposing. Were it not for pieces like these, one might think that dynamic change is a forgotten element in electronic music.

The most successful piece of the evening was Gary Chang's "Forgotten Memories", dedicated to Serge Tcherepnin. Without the overt changes and drama attempted in many of the pieces, this one went somewhere. The piece, a drone of rich and mobile harmonic content, was like a journey down a river. Not the harrowing kind; just smooth and rolling.

Two clever but disappointing tape pieces were then presented. Jon Appleton's, "Mussem Songs" came across as an example of an effect. The piece began with chords and their modulated images, eventually becoming the accompaniment for a synthesized woman's voice. It was all done very well on a technical level, but that in itself was not satisfying. "Moon Plus Moon", by Allen Strange showed the most mature compositional ability of the evening, but lacked the purpose that I would expect his music to exhibit.

Ronald Davis (Buchla 300), Robert Miller (Minimoog and custom sequencer), Darrel Johansen (Serge Modular, Buchla 100), and Jill Fraser (EMS Synthi AKS, Serge Modular) make TESE, the evening's live electronic music. While all of the members

were adept on their machines and the piece seemed to unfold as intended, live performance did not really enter into the situation. The players seemed casual, if not bored, and looked at the audience as if only to see whether they were still there. TESE's group composition, "Shuffle", was very fragmented, although well performed; but they are a new group, and time spent working together may well be the element they need to smooth out their discontinuities.

As live electronic music concerts become more numerous, interaction between audiences and players will hopefully develop a concept of stage performance with synthesizers. New instrument designs will facilitate this process.

— Doug Lynner

## David Bowie

April 6, L.A. Forum

The ghost of Ziggy Stardust was back in town in April for three dates at The Los Angeles Forum. It was David Bowie's first tour of the States since the 1976 "Station to Station Tour", and in the interval he has released two albums of electronic music, "Low" and "Heroes", that represent a radical departure from his earlier musical roles. Thus the concert was interesting for the way it answered several intriguing questions. How would Bowie blend a wide variety of musical styles into a coherent whole while at once doing justice to his new interests without destroying the validity of his past? More importantly, could he carry his audience with him, an audience that would expect a tribute to the oldies that made Bowie a star? The answers were mostly a series of surprising successes, on a number of levels.

Bowie's audience is still young. There were very few people over thirty present, and indeed the mid-teens were out in force, suggesting that Bowie is still attracting new blood. However it was noticeable that the nature of the audience has changed. Middle America has begun to latch on to Bowie. Many of the kids would not have looked out of place serving Big Macs in McDonald's



PHOTOGRAPH BY ELLEN BUZZELL

or ice cream in Swensen's, for the audience now dress as for a Saturday night out, not as Bowie look-alikes.

Bowie himself appeared in baggy grey and green waterproofs in part one of the concert, changing into white for the second half. Strangely enough though, he seemed much more like an actor out of costume, running through his old roles and disguises with a degree of detachment that was simultaneously nostalgic and ironic. Bowie is clearly in a stage of transition and he doesn't try to conceal it.

The band featured two survivors of the 1976 tour; George Murray on bass, and Dennis Davis on drums, both featured on the last two albums, as was Carlos Alomar on rhythm guitar. Utopia's Roger Powell was the synthesist, ably substituting for Brian Eno, and the band was completed by Sean Mayes (ex-Fumble) on keyboards, Simon House on electric violin, and a chameleon-like Adrian Belew on lead guitar, who seems to have the ability to sound like any lead guitarist you care to name. In all, the musicianship was excellent, very tight, well balanced and with the ability to be alternately funky and subtle. Bowie restricted himself to keyboards and vocals.

Forsaking the tradition of opening with an up-tempo number, Bowie began with "Warszawa" from the "Low" album, a solemn atmospheric piece focusing on Powell's ethereal synthesizer and Belew's guitar, which for the majority of numbers was treated and distorted. The beautiful "film noir" lighting and the air of expectation in the audience gave the piece an immediacy and edge lacking in the recorded version. Bowie's wordless vocals were greeted with screams of delight, and one got the impression that

many in the audience would have preferred a straight rock 'n' roll concert. However, everyone was patient as Bowie took us through a tour of musical influences.

"Heroes" was next, a superb performance, sung and played with passion. The rhythm section was mixed down so that the synthesizer and lead guitar were able to fully express the ardent romanticism of the melodies, providing an atmospheric backdrop to Bowie's vocals, at their very best throughout the concert. Again the lighting was subdued, focusing largely on Bowie, a phantom figure dressed for a thunderstorm.

Apart from the notable exceptions of 'The Jean Genie' and 'Fame', most of the first half of the concert highlighted songs from "Low" and "Heroes", sung and played with a fullness and energy that surpassed the albums. Bowie's seemingly unfinished ideas on "Low" have now taken on a new dimension, filled out by complex solos and a more funky rhythm section. Bowie used 'Speed of Life' as a leitmotif throughout, reprising the instrumental at the most unexpected moments, particularly as a bridge between short pieces. 'Breaking Glass', 'What in the World', and 'Sound and Vision' passed in a rush, as the audience warmed up, but everyone seemed to be waiting for the oldies. This was a shame because the new material was excellent. 'Beauty and the Beast' featured Belew, imitating Robert Fripp with relish, as Bowie pranced about the stage in an Iggy Pop persona. 'Sons of the Silent Age' slowed down the tempo, yet Bowie was by this stage gaining command of his audience. They followed him through tempo changes, false endings, and long instrumental passages, completely at the mercy of his masterful timing.

'Blackout', from "Heroes", was particularly powerful, representing Bowie's vision of urban paranoia. Belew's searing guitar riffs and Simon House's violin combined to produce an unsettling atmosphere, reinforced by Alomar's pounding rhythm guitar. Bowie was now the actor, walking in and out of the stage shadows, at one point shouting out his cries for help in complete darkness.

'Fame' was a real "tour de force", an obvious audience favorite, cleverly lit with flashing spotlights, complementing Bowie's hints at self-parody. His chanting of "fame" from the highest to the lowest register had the audience on its feet. However, just as the night was beginning to hum, we had a twenty minute interval, from which the second half didn't quite recover, due to the resulting loss of momentum.

Bowie opened part two with a selection from his most popular album, "Ziggy Stardust". 'Five Years' was truly excellent, full of drama and anxiety, superbly sung, and with Belew providing ample doses of Mick Ronson guitar licks. 'Moonage Daydream' sounded a little stilted, as if Bowie was just going through the motions, but he came back to life with 'Star', now obviously ironic, although when it was written it proved to be a blueprint for his own stardom. 'Hang on to Yourself' was adequate, but 'Ziggy Stardust' brought the loudest cheers of the evening: Bowie has never completely lost his identification with his alter ego, and his fans seem to want it to stay that way. The band managed to retain the simplicity of the album's production values: no excessive soloing, and a very restrained contribution from Roger Powell. Bowie obviously decided not to impose his later musical preoccupations on to his older material, and in general the synthesizer was used to provide a fuller sound rather than a radical change of instrumentation.

'Suffragette City' and 'Rock and Roll Suicide' were the high points of the Ziggy set, the relentless energy of the former giving way to the restrained angst of the latter. Bowie used his dramatic qualities to the full here, drawing audience response from every phrase, and this short retrospective was given an ecstatic reception. Yet Bowie did not launch into a golden oldies session at this point, but rather returned to "Low" and "Heroes", turning the spotlight on to Powell, Belew and Simon House, whose violin blended comfortably with Bowie's entire repertoire, often adding a strong melodic counterpoint to the lead guitar.

'Sense of Doubt' from "Heroes" returned the ambience to the first

half of the concert, creating a chilling yet expectant atmosphere, pierced by Sean Mayes' deadening piano motif. Powell's synthesizer dominated the piece, impressionistic yet simultaneously expressive, lullingly melodic but at the same time discomforting. 'Art Decade' from "Low" was the second synthesizer interlude before the finale, and by this stage the audience seemed to be finding an acceptable continuity in Bowie's music. The synthesizer was no longer an intrusion into "Ziggydom", but a composite part of Bowie's repertoire. Thus Powell's simulation of a train on the synthesizer at the beginning of 'Station to Station' was cheered warmly before giving away the spotlight to Bowie's vocals. It proved to be a far better song than it ever was on the album. Indeed the encores, 'Stay' and 'TVC 15' from the same LP were among the best songs of the evening. Bowie's chant of "TVC 15" was accompanied by synchronized flashing lights, reflected from a large screen at the back of the stage, and loud audience stomping along with Sean Mayes' barrel-house piano.

Bowie finished with 'Rebel Rebel', complete with Russian-like "lye-lye-lyes" from the band. Bowie exits with his tribute to the Stones, proving that old rockers seem to know instinctively when to dredge up their past for maximum effect. We heard nothing from the pre-Ziggy albums, which was a major disappointment: no 'Changes', 'Life on Mars?', or 'Space Oddity'. Bowie's Sci-Fi faze occurred way back in 1969, and he's come a long way since then. "See you again in two or three years", he said, as he walked off stage. Hope so!

—Colin Gardner

## Steve Hackett

Steve Hackett joined the ranks of progressive guitarists to depart from a commercially viable group in July of '77. Hackett escaped the cocoon of Genesis to broaden his creative horizons. An integral component of their tight ensemble, Steve felt some of the band's strengths beginning to erode, and

their permutations exhausted. "I've always tried to work combining keyboard and guitar sounds a lot so they interweave. One of the aspects of Genesis which appealed to me most was where the overtones blended." The resultant tension between keyboards and fretboard was the sound Genesis was famous for. But with Peter Gabriel's input gone, the power structure of the group was altered so that Steve was the odd man out. The magic was affected, as evidenced by Wind & Wuthering, Steve's last studio effort with the band. His contributions were minimal, both in composition and playing, which weakened the final product considerably. Steve felt the need for the band to extend its sound with the use of real orchestration and brass. His ideas and desire to split compositional duties along equitable lines were not heartily endorsed. The urge to do another solo album ("Voyage of the Acolyte" in 1975 was his first) was viewed as divisive. This, plus a Tarot reading, motivated his exit.

"I feel I've broken new ground with "Please Don't Touch." It was done in a vastly altered way from my previous work for a variety of reasons, one of which was the use of some American musicians, and recording it partially in Hollywood studios. I'm very attracted to the American approach—its professionalism, efficiency and precision. The engineers at the studios were very personally involved and strived for perfection. I used real strings—violins and cellos—on several cuts."

"Hoping Love Will Last" was a bitch to do . . . the strings took ages. Cellos, violins and synthesized guitar for effect took like four days to a week, an extraordinarily long time. That's because of my relative inexperience with real strings as opposed to Mellotron or something like that.



PHOTOGRAPH BY ARMANDO GALLO

# PROFILE

I had each violin laid down separately and tried to get the intonation right, like the old Deutsche Grammophon records. I wanted a string sound comparable to that. So we did roughs for everything first of all, then we started again and changed all the harmonies; because in the initial chord sequences, certain string passages had the effect of, like whining, and everytime that happened we had to juggle one against the other—like dip the cellos and make sure we didn't do semitones, which turned out all wrong. But the final cut achieves the feel I wanted."

On "How Can I," the harmonium effect is done with a Roland guitar synthesizer. The lyrics and sound have inspired a vignette Steve hopes to get on film, perhaps to be used in a live presentation. Visualization is the natural extension of his music. Steve "meditates, then writes. It helps me with lyrics that particularly interpret music correctly, whereby I'm confronted with the specifics of what that piece of music means in words." "Please Don't Touch" presents a variety of musical moods that succeed in inducing mental pictures aurally, allowing maximum possibilities for listener participation.

One of the most distinctive aspects of Steve's tendencies in composing and producing are the transitions both within the songs and between them. "The abrupt changes on "Please Don't Touch" are a conscious attempt to be unpredictable. Like when the title song comes thundering in, if you hear it at a fair volume it has sort of a traumatizing effect, which is quite good. Because having taken your breath away, the journey continues on a very fast kind of pace like an out of control vehicle, so you kind of take off too. That's why I put "Land Of A Thousand Autumns", something slow, before it. I think it's a characteristic sort of trait, doing things which are violently opposed, moods up-ending each other—more initially for shock value, but then because they have the effect of relaxing and intensifying."

The exploration of different musical dimensions will continue. Steve's guitar synthesizer work is branching out. "In the future I hope to do everything done on keyboards with a guitar synthe-

sizer." He is waiting for the response to "Please Don't Touch" before making his next move. "Genesis is a dynasty I helped create and now, in a sense, have to compete with. I feel I can deliver better from the studio at this point." Hopefully Steve will get deserved credit for acting as the catalyst on the album, enabling him to "produce records. I'd like to get together with an artist who is 9/10ths of the way there and bring the project to completion. I'm also flirting with film scoring. Different mediums have told me a number of things about getting involved with manuscripts of paper which I assume is something I'm going to get involved with later this year—to do with learning how to score properly, analyzing some of the great compositions. I would like to do live performances again, but not until the material, musicianship and production can be taken to the stage *right*. I'm used to involvement with expensive presentations, and at this point can't do shows as I would like. Also, "Please Don't Touch" was conceived as an album only. Guest artists and production techniques create a sound that would be difficult to duplicate live—any attempt in that direction without the original talent, might produce just a 'B' or 'Embassy' version—totally unacceptable."

—Vicky Reeslund

## Meet the Screamers

Like bloated slugs in the middle of a lettuce field, we civilized people hot in touch with the New West marvels of our stupid shit-worth culture are reduced to *talking* about the Screamers. Gonna talk about 'em, all right, in the dubious comfort of our isohomes, and Jesus, it's a wonder how Danish Modern has stuck around isn't it? And those Screamers, they just won't go away. Screamers, what can you say about 'em.

If you're smart, you won't say anything. But practically nobody's smart, and practically everybody feels compelled to say something about the Screamers, particularly the press, who are some of the least smart people around mainly

because they *think* they're smart. So about the Screamers, you *have* to say:

Click. They are an L.A.-based musical group of 4 boys with various types of strange short hair. Click. They use synthesizer, keyboards, drums and voices, no guitars. Click. They excite everything from dumb mesmerization to pogo frenzy in persons exposed to their big-beat jerk-drone music in performance.

One day probably fairly soon the Screamers will make a record, and it will be very good, and people will listen to it and talk about it. They will have read about the Screamers in Time and Newsweek and the Cupboard Companion, and they'll pass the joint of legalized commercial Tru-Flo Marijuana (or maybe just hang onto an individualized Sayf-T Saniroach) and say, "Interesting phenomenon." Make a note to consume them if they should come through town and look at that hair and rumors of gay activism and YOU'D NEED TO SLOG INTO BATTLE WITH THE HATE OF CENTURIES AND AN ATOMIC BAZOOKA ON EACH ARM TO MAKE THE SLIGHTEST DENT IN THE SOLID WALL OF BULLSHIT THAT HAS KEPT ANYBODY FROM KNOWING ANYTHING SINCE ADAM BIT THE APPLE.

If you want to *understand* something read about John Travolta or some other symbol which was made for the media and has no existence outside the media. The Screamers are different, probably unfortunately for their wallets. *Live*: Tomata the singer sounds like the kind of artificial voice box they have to put in after surgical larynx removal. His face can instantly assume any caricature. He will sometimes move his hands within a drone like an Egyptian death spirit. Gear on synthesizer is usually either like one of those floor mounted punching bags or a doctor in mid-operation. K.K. the drummer stares at an empty space with his mouth open, absolutely intent on popping people's heads around. He looks as if he never stops. He has to be transported place to place on a platform complete with drums, never ceasing to beat.

And this description is probably a waste of time. The Screamers

do something outside words. I don't know what most of the lyrics to the songs are, and I really don't think I give a fuck. I didn't understand the Screamers at first and after considerable contact I still don't understand them, thank god.

Nevertheless you have to do something, can't just sit around, never too old to go to school, right? So we go to the house where Gear and Tomata are, talk to them. They're due for a photog session so Tommy Gear has just shaved, obviously with a new blade because he's got bright red patches all over his face and looks like the Red Death. He speaks lightly and seriously with one side of his mouth raised about half an inch above the other. Tomata comes in from getting some Danish. Everything he says has the same weight, though he goes through a variety of acting styles. One might expect him to offer you a damp rag for your forehead. K.K. comes in late and the way he talks is kind of hard, flat, blunt and funny. He is rumored to be from the Midwest. Paul the new keyboard player is sort of bright and young looking, seems like a nice guy. He is duly exhibited.

So now you say, "Here's where I find out what those Screamers are all about. They're gonna talk and *explain it all*." Right, all that stuff about how they hold seances to raise the ghost of Aleister Crowley, and they sleep on beds of nails and can turn themselves inside out at will, and how Liza Minnelli comes over for late brunch and a quick dip, and their mothers were transvestite Greek Orthodox priests and their souls are furnished in tasteful elegance and the resultant effect on their creative natures has produced music that is the essence of BLA, BLA, BLA and BLA, hopefully summed up in one pithy statement like "What today's youth wants and needs is a lot of avocados."

Wrong. My guess is all the Screamers really want from an interview is to get their pictures in print so people can get curious about them. So let's not even pretend any of this means much, and just slop a bunch of it out for your curiosity. There's a bunch of sawed-up wood lying around.

[Continued on page 50]

# Your Instrument of the Future

**Technical Research Institute Inc.** is committed to the development of a keyboard musical instrument that produces the sound of all acoustic & electronic musical instruments. It uses **Laser-optic memory** discs, does not have tapes to wear & many heads to adjust. It is



ORCHESTRON MODEL X  
PHASE FOUR...

not a souped up combo organ with simulated pre-sets, rather it produces its sounds by **Modulated Light**. It has **Full Polyphonic** capability, every note will play. Laser-optic technology allows the keyboard musician to produce the actual sounds of human vocals, string sections, horns, pipe organs, synthesizers, or any sound that can be recorded. Every



ORCHESTRON MODEL  
DOUBLE "D"...

Orchestron is packaged in the worlds most rugged keyboard case by **Voyager Keyboard Systems** Call now for more information 813-522-2118.



ORCHESTRON  
MODEL "D"...

**There's none other like it.**  
**Orchestron**  
A PRODUCT OF TECHNICAL RESEARCH INSTITUTE INC.

Box 1800, Pinellas Park, Florida 33565

# The Most rugged keyboard system...custom built for you!

You have a need for a system that provides function, size, rugged roadability, for your keyboards at a price you can afford. From this need evolved **Voyager Keyboard Systems, Inc.**

The Voyager people provide a custom packaging concept for Keyboard equipment and accessories, pedal systems for Guitarists, special mixing consoles, and discotech turntable systems. Modular construction and wiring allow fast service and repair. Aircraft electronic shock mounting technology gives your equipment the protection necessary for commercial shipping.

Custom etched panels provide you with controls designed with your needs in mind. One power cord and a single output panel reduce the set up time and trouble of several instruments and modifiers to minutes. Your complete system is powered at the touch of a single switch. Our quality standard is high and displayed by the **Voyager Case** in which all your instruments can be repackaged. Ph. 813-522-2118

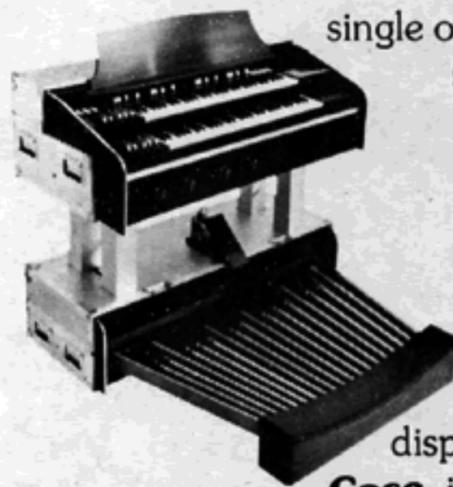

**VOYAGER**  
**KEYBOARD SYSTEMS**

Bringing It All Together For You.

Box 1800, Pinellas Park, Florida 33565

## Part One: On the record business, the law and lawyers, hype, and hardware. Next issue Zappa speaks on musicians, composing, music and politics, instruments, and academia.

by Chris August

**Chris August:** *How were you able to get a recording contract, how were you able to get on Verve?*

**Frank Zappa:** That was an accident. We had gone around to all the record companies, shopped our demos around and done all the things that a new group does in Hollywood to get somebody at a record company to listen to them, and been turned down by everybody. And finally this guy, Tom Wilson, who was the producer at MGM, was down the street at one club while we were working at the Whiskey a Go-go, and he was induced to be dragged away from his lady friend and come down and see us play just for a moment. And he walked in while we were playing the Watts Riot Song.

**Synapse:** *"Trouble Coming Every Day."*

**Zappa:** Right. That was a rhythm and blues kind of number. He walks in and he sees the band, sees us play that. We finish the set, I come out and shake hands with him, he said he liked it. He said that he thought we could make a deal, and he walked away thinking that he had signed a white rhythm and blues band. And they gave us the astounding sum of \$2500.00 to sign the contract, and we went in and started making the record and the first song we recorded was "Any Way the Wind Blows," and the second song we recorded was "Who are the Brain Police," and that's when the phone calls started going out to New York. You know, uh-oh, what happened?

**Synapse:** *Were they committed to manufacturing the first one?*

**Zappa:** That's right, yeah it was already signed, the money was spent, and they didn't really know what they had bought. So, like I said, it was an accident. If he hadn't been there and we hadn't been there and we hadn't been playing that one particular song when he came in; if it hadn't been a certain hour of the night where the crowd at the Whiskey a Go-go was up dancing and looking like they were having a good time to this particular number, well, it might not have happened.

**Synapse:** *Right now you're in the middle of a dispute with Warners. Why is it that you have a difficult time with record companies?*

**Zappa:** Well basically because none of them mean you any good. It's difficult, if not impossible to get a fair deal if you're an artist. This may sound like some sort of rude paranoia but it's not, it's absolutely true; and I believe that the upcoming anti-trust investigations will bear this out. In Los Angeles, there are several law firms who specialize in show business law, right? It's a specialized field just like copyright law, divorce. There's only a few people who do it; and among the few who do it, there's a

few who are famous, and who have a lot of connections, and those are the top ones. But they're working both sides of the fence because not only are they representing artists, they're representing record companies, and the record company is the guy that's really paying them their salary. So if you're an artist and you go and you get the best lawyer you can get from the best firm you can get, all you're really doin' is gettin' reamed, because the guy owes his ass to the record company, see? And so it's difficult, if not impossible to have adequate representation if you're an artist when you go to negotiate your contract. And to make it even worse there are some law firms who represent several major record companies.

**Synapse:** *How do you get around all that? You must have known that before you got into a contract situation.*

**Zappa:** There's one thing that I have always known: that I don't know anything about the law, and I think that the sooner people realize how little you can know about the law—even lawyers don't know about the law. The situation with law in the United States is disgusting because all it does is perpetuate red tape, it perpetuates the employment of people who deal in law which is a fantasy. Law does not deal with right and wrong, as it should have from the very beginning. It does not. It deals with ways in which people can commit various types of white collar crime. And the people who are operating as lawyers 9 times out of 10, are on the fringes of one kind of a fraud or another. They're all bending the law to suit the purposes of either themselves or some client that they have, you know? And when people have to make agreements on paper that bind them to one another for a certain period of time to perform functions, like a record contract for instance, it has to be set down on paper, just so the parties know what it was that they were talking about in the beginning, okay? But by the time you've agreed on your points, and the time that a lawyer draws it up, there are so many little doodads they can stick in there that can completely change the spirit of the contract; something that starts out to be a reasonable deal winds up being indentured servitude by the time the lawyer and the other people get done sticking it to you. Because there is little or no good will in the record business, or in any business for that matter. Business is a process of making money.

**Synapse:** *Do you think setting up independent labels is any help?*

**Zappa:** No, it's not.

**Synapse:** *Because you still have to go through them for distribution?*

**Zappa:** That's right. That's the weenie. Because if you seek independent distribution what happens is the little distributors don't pay you. Say you're a small label—you pay and you have your records pressed and you pay to have them shipped, and they arrive at a small distributor and he sells them and he collects, but he don't send the money back to you, and then you have to sue him, and you have to sue individual distributors all over the United States. You know what that costs you in terms of legal fees? Forget it. See? So your other option is independent label, go with mass distribution through a single company—through Capi-

tol, through Columbia, through Warner Brothers whatever, right? You make a sub label deal. Then you only got one guy to complain about about getting paid.

**Synapse:** *What do you think of the music that's coming out that's called New Wave, or punk music?*

**Zappa:** I think it's just a way for people who can't play to earn a living.

**Synapse:** *Would you rather that they be working on cars or—*

**Zappa:** No, because considering the way they play, I wouldn't want them working on my car; but I think that it's good that this music is available for people who like that music. But let's be honest about what it is. It is not the wave of the future, and it is not the voice of social protest of today. It's just another record company hype. I mean, did we all believe that Bruce Springsteen was the new Bob Dylan, or what?

**Synapse:** *When did you first become aware of the synthesizer?*

**Zappa:** I've known about the synthesizer since I read about Oscar Sola's Mixture Tratonium, and it's been over 20 years. It was reported in this article that it makes sounds like chordal glissandos of kettle drums and things like that, and I said, hey, that's for me, but of course in those days there were no synthesizer records, and anybody who was dealing with electronic music had to be in "New York."

**Synapse:** *Were you aware of other people doing things in Europe, like Stockhausen, and people...*

**Zappa:** This was before Stockhausen.

**Synapse:** *But in the early 50's, after the war, when they started doing tape pieces?*

**Zappa:** Yeah, Pierre Henry and yeah, I knew about that stuff. In fact there was a record store in Clairmont California that occasionally got some of these unusual, very rare recordings, and since it was so primitive in those days, you could actually go into a record store and listen to the record before you bought it. I actually went in there and listened to that music. I had a chance to really hear it. Of course I couldn't afford to buy it, but I heard it. I have since acquired a lot of those records, though. I have a pretty good collection of electronic music.

**Synapse:** *Are instruments developed because of a need, or do things appear and then excuses are made for the use of them?*

**Zappa:** No, I think that, from talking to the people I know in the hardware end of the business, they won't do anything unless they can sell it. I know people who have brilliant minds that could probably build any kind of a noise maker you want, but either don't have the money, or don't have the inclination to develop a new process or a new black box unless there is some potential for them to earn money from it farther down the road—which is logical because they have a brain and they want to earn a living from what their brain does and they're only going to develop things that they think are merchandisable, and the problems of merchandising new electronic devices are pretty complicated. I'm sure that there are a lot of things that could exist right now that won't, simply because there's no way for the guy who builds the box to make a buck off of it. ©

To be continued next issue.

DEVO is five young expatriates of Akron Ohio: two pairs of brothers, and an unrelated drummer. Alan, the drummer, as drummers are wont to do, went to a baseball game instead of the interview. This is not crucial in terms of getting a total impression of DEVO. Although they spend much time explaining each other's eccentricities, they have a peculiar oneness about them which goes far beyond the actuality of other groups I have known, and even approaches the ideals of unity so espoused by groups in the sixties. Mark or Jerry, the older brother of each pair, will begin to talk about something, and a younger brother (both are named Bob. For convenience, Bob 1 and Bob 2) will add a *soto voce* comment which is somehow inserted without interruption into a space apparently prepared for it. Often, the idea will be completed by a third DEVO; and then, in the tradition of the Greek chorus, will be given final, brief, usually ironic comments by each DEVO in turn. For this reason, the individual responses in this interview have been collected under the group name.

by Pat Gleeson

DEVO: *Synapse* . . . we thought it was a medical journal.

Pat Gleeson: *It is, on the grounds that electronic music is good for you. Bruce Conner was telling me that you were composing some of your music using synthesizers, then transferring the ideas over to other instruments. Is this true?*

DEVO: Not repeatedly. I think in instances we did. "You Got Me Bugged" we started off on the sequencer and we tried to use instruments to imitate what the sequencer did.

Synapse: *For the bass line?*

DEVO: For everything. It was the melody, then we took it down into the



# DEVO

bass. It was a PAIA sequencer, and we used it to turn on three different synthesizers, so it was doing all the parts. Then we expanded it by breaking it down and taking something that was totally electronic and copying it with different instruments.

Synapse: *How did you keep it in sync?*

DEVO: Well the PAIA sequencers, although they're really crude, have gate outs for each of the steps; so as many steps as you have, you can send information to several synthesizers.

Synapse: *You guys have a special affinity for low budget equipment. Why is that?*

DEVO: Lack of funds. Financial reality. But you can make that work for you. Once you get used to shitty equipment, good equipment lets you down. You have to get to *really* good equipment so that you can re-approach what you can get with shitty

equipment. It's the whole middle ground that's always a drag—as it is with everything. The best synthesized equipment allows the crudest sounds, although consciously chosen and easily repeatable. And there's your full circle—from crude chance with crude instruments to the appearance of crudity with sophisticated electronics.

We had that problem in Germany, and also at your studio, using new Minimoogs. Our Mini is so beat up that it always sounded distorted anyhow; and then we were running it into Teac boards and tape recorders, which had higher distortion levels. So when we recorded at your place and in Germany, we were using brand new Minimoogs and expensive boards and recorders, and it sounded like "Switched-On Bach." It was too clean.

Synapse: *But what I noticed when I*



PHOTOGRAPH BY HERB WREDE

listened to the tape that Mark brought by after the record was finished, was that you could hardly tell the difference between the tracks that were recorded at Connie Planck's studio, and the tracks that were recorded at mine. Then, when I compared the garage tapes with the record, again there were very few differences that I could hear.

**DEVO:** Exactly. We work hard for that. The only differences might be the noise levels. No one wants to buy a record with a lot of noise on it. But we always sound like DEVO.

**Synapse:** How did that come to be?

**DEVO:** Well you can take the boy out of the country, but . . .

**Synapse:** . . . usually you can't get the country into the boy. How did you get that kind of assurance so soon; how did it happen?

**DEVO:** No one grew up right. I don't mean they had horrible childhoods. I mean no one grew up; no one figured out how to be an adult.

**Synapse:** How soon in life did the two pairs of brothers meet?

**DEVO:** We avoided each other as long as possible. Then we got the two younger

brothers to do what we wanted them to do—they were the only ones we could get, because what we were doing wasn't socially acceptable. No one wanted to hear it. People who like electronic music generally didn't feel that we were making electronic music because we weren't pretty, we weren't reverent, we didn't worship electronic sounds, we had no classical background. And what they thought of as electronic music was basically keyboard antics switched over to electronically engendered sounds, or highbrow, serious art, like Subotnik. We were *applied*, and in that sense real folk electronic art.

**Synapse:** Mark, what have you got on your guitar wrapped up in all that silver tape?

**DEVO:** It's called a "Frequency Analyzer." Just some device that Electro-Harmonix made for guitar players. And nobody ever wanted it, so they immediately dropped to about twenty-five bucks. Then everybody that bought one gave it away 'cause they didn't know what to do with them; they didn't sound pretty. So we got one.

**Synapse:** It makes some ring modulator sounds.

**DEVO:** Yes, it's got a fixed oscillator which you can set yourself, and your instrument is the other input . . .

**Synapse:** So it's really not a frequency analyzer at all.

**DEVO:** It calls itself that with real psychedelic lettering though. And nobody else uses it like we do—no one else has sought out dirty visceral sounds the way Mark has, and applied them to a three minute format.

**Synapse:** But he's a dirty visceral guy.

**DEVO:** Wait a minute, he's wearing tuxedo pants.

**Synapse:** And, for the record, iridescent blue plastic shoes.

**DEVO:** Plastic—exactly. We're the only people who aren't worshiping electronics or ignoring them on some hippy principle that they're against man. All they are is a possibility—it's a wider vocabulary, a whole new range of sounds that lets you get closer to something essential and basic. Most people don't realize that. They actually use electronics to get further and further away from the center by adding layer on layer of pretty and pretentious electronic musings. We're not doing that. We're reducing it down to minimal, basic pieces of discreet sound.

**Synapse:** Do you think that has anything to do with the reaction you've had from audiences so far? You've certainly had the most extreme reactions of any group I can remember as far back as the early sixties.

**DEVO:** That's what's being imparted to the people, that basic essence they've moved away from, and that, consciously or unconsciously, they are seeking out.

**Synapse:** People are fighting to get closer to the stage. They come dressed as DEVO clones. There's this hero worship, and your

first LP isn't even released yet. People are beginning to take their styles in life from your styles. That must seem strange, even a little funny . . .

**DEVO:** It's not funny, but it's necessary for those people.

**Synapse:** When that happened in the sixties, the groups that were involved felt some responsibility for those people.

**DEVO:** Well, it happens because we're performing *and* responsible. It's not because we get that reaction that we feel the responsibility. We get the reaction because we're responsible to begin with. Anybody could be doing what we're doing, and the same thing would happen, but no one else wanted to. And the way the electronics relate to that, and will continue to relate to it on an even wider scale, is to provide an experience which is not fantasy and escape, but is more like catharsis. And only the most uptight kind of people avoid that sort of experience because they don't want to remind themselves of what they're avoiding or what they forgot. But the great majority of people who don't have a voice, want to have someone do it for them.

**Synapse:** Well, now, let's talk about record companies. The last I heard, the Warners album was off and the Virgin album was on, and Warners was going to sue you—is that all straightened out?

**DEVO:** Probably.

**Synapse:** Entertainingly?

**DEVO:** We got a movie script out of it. We had a sketchy script about the record business a year and a half ago. We were playing most of the parts; but now we have the hardcore data. We don't need any more material. That script's completed.

**Synapse:** Uh-huh.

**DEVO:** Let's just say that the way we've been testing and experimenting is "DEVO takes on the music business." Needless to say, we found out more than we wanted to know. Maybe it was some kind of self-fulfilling prophecy, since we could have predicted what would happen; but being spuds ourselves, we had some sort of perverse urge to actually have it happen. It couldn't just be a paranoid fantasy, we had to actually see it and hear it.

**Synapse:** What happened?

**DEVO:** We went too far. They tricked us; they all trick DEVO.

**Synapse:** This seems to be a good time to get into something like your latest equipment acquisitions.

**DEVO:** Yes, we just got some real cases for our synthesizers, so we don't have to carry them in cardboard boxes anymore. This is going to save money on gaffer's tape too.

**Synapse:** What've you got on stage now in the way of synthesizers?

**DEVO:** The Minimoog, and an Odyssey. We looked at a Sequential Circuits Prophet too, but we can't get one; everyone's back-ordered. We did get a Sequential Circuits programmer for the Mini. And we're plan-

ning to re-introduce our electronic drums again soon.

**Synapse:** *Whatever happened to the originals?*

**DEVO:** Oh, the ones that Mark's youngest brother made? Well, they started out as Barcus Berry pick-ups attached to each drum, just to add a little something. Then we incorporated a graphic and an echo-plex—finally they got out of control. We have some interesting tapes of them going out of control. The cymbals sounded like an international silver string submarine band and the little rascals junior—did you ever hear that? Just like a garbage can that's at one end of a hundred foot long pipe, and your ear's on the other side. Anyway, it just added a metallic unpleasantness. Then we refined it, and put together our own pick-ups that were on practice pads, and we mounted these on chrome muffler tubing. . . . Then we ran all the pick-ups into ring modulators, and some other effects, and finally we added a trigger device so we could get it to play the synthesizer. Then it all broke down. We started a graphics shop so we could get the money to put out our first record. . . .

**Synapse:** *You know, there's something about what you're doing, even though you're playing about \$4.19 worth of Synthesizers on stage, that makes you an electronic music group. I don't know what it is; I feel the same way about Terry Riley, who doesn't play synthesizers at all. Maybe in DEVO's case it has to do with the automata quality, which people are always trying to get away from, and in my opinion wrongly.*

**DEVO:** Yes, we think so. It's some kind of mentality about acoustic sounds. A lot of people play electric guitars, which are electronic, like some kind of great big acoustic instrument, where we always consider them to be what they are, *electronic*. We like the way Pete Townsend played guitar in the sixties. That was a nice innovation. He played it like an electronic instrument. Since then nothing's happened. A bunch of people who've made a lot of money in the business have bought themselves expensive toys, and all you hear about is sweetening and enhancing and endless layers of keyboards and guitar tracks electronically modified to augment an essentially outmoded way of thinking about music. It's like the way cars still looked like horse-carriages even though they had engines in them; because people hadn't hit on the idea yet that there was no longer any need for that form for something that carried them around using an engine. So this change is just happening now in music. We think in terms of electronic instruments, and we think minimal. And we make everything make the most immediate basic sounds that we can think of in our bodies. Which is what these instruments are for, as far as we see it. We're making *songs*, which is another important thing—not extended pieces of pure

music. Our music has lyrics, and an applied purpose.

**Synapse:** *I remember that the tunes we cut at Different Fur were all right around three minutes—within a few seconds—to begin with. By the way, how did you like Who's Next when that first came out?*

**DEVO:** Yah, Townsend was right. He was going in the right direction. It was nice to hear things like "We Won't Get Fooled Again," in terms of the rhythm tracks being done with sequencers. But we like Hound Dog Taylor too. He played a guitar so cheap it just sounded like transistor radios, white noise, with tonality.

**Synapse:** *What kind of guitars are you playing now?*

**DEVO:** Usually a Gibson L6-S. We're still playing too many notes, and we're hoping that once Mark gets more synthesizers, and we add electronic drums again, and the guitar players can plug in through Avatars, something like that, we can further reduce the number of movements we make for sound.

**Synapse:** *You've played the Avatar?*

**DEVO:** Just in stores, window-shopping. But they seem to apply to some of our more minimal stuff, particularly the older stuff. The only thing wrong with our older material is we didn't have the sounds to go with the ideas, like with the original electronic drums. The paradox was that the way they were, they were more limiting than the original acoustic drums, so people OD'd on the sound faster. So until you come around to an electronic sound that is wider in its possibilities than the original acoustic sound, you're even worse off than before in terms of attention span. So now it's coming around—then too, we may have been too much in love with crudity.

**Synapse:** *By the way, speaking of limited sounds, how did you like the new Kraftwerk album?*

**DEVO:** Oh, the disco one. It sounded like disco. A lot of it sounded like a rip-off of Giorgio Morodor. It sounded a little dry.

**Synapse:** *It was very dry. I liked the album; I didn't expect to.*

**DEVO:** I heard they were getting robots to play the music on stage so they could watch their own concerts.

**Synapse:** *You know, this past month almost everyone has been through here—a lot of different kinds of synthesists—and the funny thing is, hardly anyone has a good word to say about anyone else. I wonder why that is.*

**DEVO:** It's Western Capitalist Society—obviously people are not geared to work together.

**Synapse:** *Sometimes I get uncomfortable with someone who's doing something along the lines of my own music, and I don't know whether it's just self-criticism projected onto someone else, or whether I think I can do it better, or just what it is. . . .*

**DEVO:** Uh-Huh.

**Synapse:** *What about Brian Eno? Musi-*

*cally, I mean—I know you got along well with him personally, and that you thought he was a good producer. . . .*

**DEVO:** Oh, musically. Well, he's refined. He's refined himself into a nice little slot. But what can you say about anyone? We hear things in almost everything that we can use, and we hear groups that we think we would like if we were producing them.

**Synapse:** *Like who?*

**DEVO:** Suicide, a band out of New York, and Pere Ubu from Cleveland.

**Synapse:** *You'd like to produce them?*

**DEVO:** Yes, but I doubt it would be reciprocated.

**Synapse:** *None of the other New Wave groups have anything good to say about you guys.*

**DEVO:** Well, because they have a certain religious reverence for what they're doing, which they're calling something else . . . even with New Wave there's a certain basic dishonesty about what's being done. Essentially that it's not new. And we're presenting them with the truth, and they don't like it, just like anybody who's being dishonest doesn't like to be confronted with it. So they try to dismiss us with comments like "visually too perfect," or "silly" or "commercial."

**Synapse:** *There may be something like a feeling of impotence a group might have if they look at another group and suspect that they have a potential to reach everybody, whereas in their own case, the audience may be very limited in its potential, both as far as the size goes, and the time the audience goes on. . . .*

**DEVO:** Well, everything's limited. The society encourages it, and creativity is just another manifestation of that—of being one-dimensional; and most groups are one-dimensional. They have just a piece of one idea, and we have *balance*. . . .

**Synapse:** . . . *not the first word that would occur to me in connection with DEVO. . . .*

**DEVO:** . . . exactly. But they have to see that the insanity is programmatic, and that's what they're threatened by.

**Synapse:** *You're making this movie with Neil Young. How did that get started?*

**DEVO:** Well, Dean Stockwell's in the movie. He's a DEVOtee. He knows Iggy well. Iggy brought him to see us in Hollywood, then Dean played Neil some of our songs, and Neil liked them. Even though they're stylistically different, they appealed to some part of his sensibility, and he probably thought it would be hip to have the total incongruity of DEVO in his film, his cosmos. And we were into the absurdity of it from our end; and then, too, we're bimbos for footage of ourselves.

It doesn't matter how they edit us, how they use the footage, they can use the footage or not. . . . Neil was the only one five years ago who was into insane one note guitar, so we like him. ©

# composing dynamic laser light sculptures LET THERE BE LIGHT

by Ronald Pellegrino

The information contained in this presentation is a highly condensed form of one section of a book entitled "The Electronic Arts of Sound and Light" which is soon to be released by Van Nostrand Reinhold. The section on which this presentation is based considers electronically generated light forms, which are analogous to electronically generated sound forms. It also examines the fundamental conceptual and expressive bases from which electronic light and sound forms are derived.

Laser scanning systems, along with video and oscillographics, are logical visual extensions of electronic music instrumentation and its associated thought processes. A simple laser scanning system emerges as the most elegant of the three visual extensions for the following reasons: it is easily portable; it is relatively inexpensive; it can be coupled with the outputs of a synthesizer or a computer in the same direct fashion as loudspeakers; its operation is real time, so it is a live performance instrument that does not require a recording medium; its generating and projecting systems are one and the same; and it produces an image whose size is a function of the distance from the scanning system to the reflecting surface, and whose general character remains precise within a wide range of distances because of the laser beam's propensity to remain tight and focused. A laser scanning system works equally well in a small studio, an auditorium, an arena and an outdoor situation. The general rule is: the greater the projection distance and intensity of the ambient light, the greater the power requirement for the laser. In performances before audiences of over fifteen hundred people a one milliwatt laser proved adequate. The principle staging requirements for laser light forms are a dark viewing environment and a light and flat reflecting surface. A reflecting surface composed of any surface variations from gentle curves to sharp angles will distort laser light forms.

In every medium an artist collaborates with his tools and materials. The design of the tools exerts a strong influence on how they will be used. The nature of the materials predisposes the forms the materials will assume. The visual forms produced by the interaction of laser light, a scanning system, electronically generated and volt-

age-controlled waves, and a composer/performer are best viewed as dynamic laser light sculptures, analogous to musical forms in their unfolding.

It is helpful to accept the notion that the aesthetic requirements of sculpture can be as well served by an illusory image as by a real image, and by dynamic and ephemeral forms as by permanent forms. Much of the charm, beauty and power of laser light forms derives from the feeling that the forms have no matter.

As with most instrument-based arts, the techniques of sculpture have historically reflected the technological level and character of the society of its time. Electronic systems and their extensions are undoubtedly the most powerful influences on the current state of human affairs for some good and much evil. Exploring the potential of electronic instruments in the arts serves as a positively biased counterforce to the generally destructive applications of electronics in society.

Laser light is characterised by an incomparable living quality which derives from the method by which it is generated. With incandescent light, the atoms in the lamp filament are excited to higher energy states through heat energy generated by the electric current passing through the filament. As the atoms return to lower energy states (the ground state) to be excited again, they release the energy difference between the high and low states in the form of light. The significant difference between the laser and other light sources, such as incandescent lamps, is that the laser light source material provides a particular form of energy state in which the excited atoms can and do pause before returning to their ground state. They tend to remain in that state of pause (called a metastable state) until stimulated into returning to the ground state. In this last step they emit light having exactly the same wavelength as the light which triggered them into leaving that state. The atoms are thus stimulated into emitting monochromatic light, light of a single wavelength or a very narrow band of wavelengths, which excites in the observer the sensation of a single color. On the other hand, the spectrum of incandescent light and sunlight is a broad continuous band of colors caused by a mixture of all visible wavelengths.

Single wavelength or single frequency waves are said to have frequency coherence.

To take an example from the field of sound, imagine the spectrum of noise spread over the entire audio band, 20 Hz to 20 KHz. Noise has a minimum degree of frequency coherence. As the noise is filtered into successively narrower bands it is assuming higher degrees of frequency coherence. The extent to which the band of noise approaches a single frequency can be specified by referring to the width of its frequency band as a percentage of the center frequency. If the bandwidth is 10 Hz and the center frequency is 500 Hz the sound has a 2% frequency spread.

Frequency stability is another way of specifying frequency coherence in a wave. Good audio oscillators have an extremely high degree of frequency stability, therefore a high degree of frequency coherence. In fact, the principle that led to the laser was first developed in connection with high frequency stability oscillators required in certain radio applications. An instrument called the maser (an acronym for Microwave Amplification by Stimulated Emission of Radiation) uses atomic processes to achieve frequency stability. From microwaves the principle was extended to light waves, and the laser emerged (Light Amplification by Stimulated Emission of Radiation).

Normal incandescent light is noiselike in character. It has a low degree of frequency coherence and poor spatial coherence as well, because the luminous area is very large compared to a single light wavelength. In effect, incandescent light is generated randomly and independently over the extent of the luminous area, whereas the light generation process in the laser causes the light to be emitted in the form of plane waves, with wave fronts many wavelengths across.

The gas laser consists of a glass tube filled with a special gas mixture. Near the ends of the tube, high voltage is applied across two electrodes which causes an electrical discharge to take place. The discharge causes the gas to glow, and the tube looks much like an ordinary neon tube. The gas laser differs from a neon tube because its gas mixture provides the necessary metastable state in which excited atoms can temporarily reside. The energy difference between the metastable state and the ground state corresponds to the energy of the single color light which is radiated. A

[Continued on page 38]

# CAMERON JONES



PHOTOGRAPH BY BILL MATTHIAS

Cameron Jones is the kind of guy who rides his bicycle through a Vermont winter carrying a double bass. That's good, because a lot of determination and a strong sense of humor must have been a big help in the process of designing a completely digital synthesizer.

by Doug Lynner

**Douglas Lynner:** *How was the Synclavier conceived?*

**Cameron Jones:** Actually, the Synclavier has its roots in a project at Dartmouth that was begun about five or six years ago. In 1972, Dartmouth College got a Sloan Foundation grant to investigate the field of computer assisted instruction in music. I was a student at that time and Professor John Appleton, and a research engineer named Sidney Alonzo were the people who were carrying the ball. There was money in the grant to purchase a computer and to work on the development of a digital sound generating device. The object was to program the computer to play a piece of music and ask students at a terminal various questions

about the music. The most obvious thing to do is ear training—you play an interval and ask them whether it was a fifth or a fourth. There was a lot of excitement in that field at that particular time. I don't know whether there still is or not. That's much too big a field for New England Digital to think about. Anyway, that's where we met, and that's where we began on the design of the digital synthesizer. There have been three or four different working models of the synthesizer. The first two were fairly crude, but of course the final one has FM and arbitrary wave shapes.

**Synapse:** *Did the instrument that was used on the record, the Dartmouth Digital Synthesizer, have linear FM and arbitrary wave forms?*

**Jones:** Yes. The synthesizer that was used to make the Dartmouth Digital Synthesizer album was virtually identical to the synthesizer that's in the Synclavier now. About two years ago, New England Digital completed the development of their sixteen bit computer, which we call Model A. Once we had the computer designed, and the synthesizer designed, we could then visualize a portable package which was later named the Synclavier.

**Synapse:** *When you were thinking about what the Synclavier's capabilities would be, were you using any analog frames of reference as examples, or was the concept entirely*

*independent of the analog frame of reference?*

**Jones:** That's a good point. I took one course in college from John Appleton during which I learned to use the electronic music studio at Dartmouth. So I became familiar with analog equipment then, but a lot of our design of the synthesizer was based strictly on our own conceptions of music. John of course is a professional musician, but Sidney and I are at least amateur musicians, so we had some sort of feeling for the music itself. But the driving factor was what sort of techniques are possible using moderately priced digital technology. There are several \$200,000 digital synthesizers in the world, one at Bell Labs, one at Stanford, and I'm sure there are others. But we were interested in deciding what functions you could do with a more affordable amount of hardware.

**Synapse:** *So did you have a group of what you considered to be attractive functions, and then decided what of those functions you would include?*

**Jones:** It turns out that the types of functions that you can do are pretty obvious when you are familiar with the technology. There wasn't a great deal of time spent in deciding what features would be included. What happened was that we came across a couple of tricks—and we have filed for some patents in this area—that allowed us to use a very small amount of hardware to

# “A lot of our design of the synthesizer was based strictly on our own conceptions of music.”

create fairly impressive sounds. And those particular techniques make it very easy to do certain things such as FM and arbitrary wave shapes, but make it much more difficult to do other things that some analog equipment does. So it's really a different approach to sound, and it's very confusing to compare the two; although of course it's what you have to do because of the great body of people that are familiar with analog equipment.

**Synapse:** *Let's go over the basic operating parameters of the system and define the basic components.*

**Jones:** Sure. The actual system of course has a sixteen bit computer, a relatively powerful one too, and a sixteen channel digital synthesizer. That's really the heart of the system right there. The clavier and the control panel, which is what the performer or composer uses to specify the sound that the system makes, are really very simple assemblages of switches and lights that form an effective way for the composer or performer to talk to the computer program itself. So there's a program running inside the computer, and the composer interacts with the buttons and the display to tailor the sound that the machine generates when a key is pressed.

**Synapse:** *In terms of the basic sound parameters of the system, one of the new capabilities is linear FM and arbitrary wave form creation. Could you describe . . .*

**Jones:** . . . the parameters that affect the sound? Sure. I just want to say one thing first. There is actually, as I said, one of these computers inside the system. So the actual limitations of the hardware itself are much different from the limitations of the one program that we have been running in the machine and showing. In other words, the actual synthesizer is capable of making sounds that use for example, four channels of the synthesizer in a circular FM pattern, and that's a feature I just didn't include in the current program because it's already complex enough, and I wanted to get some experience with the current program first. So let's first of all speak of the actual way that the composer interacts with the current program which is running inside the computer. He specifies a sound by constructing, first of all, a four segment volume envelope, very much the way a regular analog transient generator works; but then there's a second and independent four segment envelope on the index of modulation. There are two parameters that affect the FM sound. First of all, there's the amount of modulation which is performed, and that's controlled by the index of modulation. The second parameter which affects the sounds is the ratio between the two frequencies that

are being modulated. For example, if they are equal, which would mean that your ratio is exactly 1:1, you would get a certain type of sound, whereas if the two frequencies are in a ratio of .379, then you end up with a completely different sound coming out of the device.

**Synapse:** *How would you describe the process of arbitrary wave forming?*

**Jones:** The synthesizer itself has four wave shape memories that are used to store an actual picture of the wave form that you want to produce. The wave form is specified by 256 numbers that represent the shape of the wave form. In the regular Synclavier program, we offer controls on the panel so that the composer can construct a wave shape by specifying its harmonic spectrum. Of course, you could specify a wave shape by just listing the 256 numbers, but it turns out that, first of all that's awfully cumbersome, and in general the results are unsatisfactory because if there is any sort of discontinuity, in either the wave form itself, or its first or second derivative, you're going to end up with a wave that just sounds like a buzz. So you get better results by specifying the harmonic strengths. In this case, it's the first sixteen harmonics; each has its own level, and in that mode the computer is actually calculating the desired wave shape by using a software additive synthesis. It computes the fundamental, then it computes the first harmonic, scales it by the coefficient and adds it in. So first of all, constructed in the memory of the computer is a picture of the wave, and then it is transferred out to one of the synthesizer wave shape memories. It takes about a quarter of a second for the computer to calculate an entire wave form.

**Synapse:** *So does that run through the harmonic envelope? In other words, do those harmonics vary in their amplitude and appearance in time?*

**Jones:** No. With this particular system, it's the computer that is actually calculating the wave form and loading it into the synthesizer, and the synthesizer uses that basic wave form for the production of the sound. You can take that wave form and perform frequency modulation using that complex wave form.

**Synapse:** *Then that would be subject to the harmonic envelope?*

**Jones:** Right. Therefore, if you started with the complex wave form, you could affect its richness by adding FM to it. Now actually, a lot of people want to experiment with a sound where there is for example, a different envelope for each of the harmonics. This requires the use of one channel of the synthesizer for each harmonic. This would entail a software package we're working on

that turns the system into essentially a monophonic instrument instead of a polyphonic instrument; and when you press a key, all 16 channels of the synthesizer are applied to that one sound. So, for example, the harmonics don't have to be perfectly harmonically related; they can be slightly sharp or flat, or they can be a random sequence of frequencies each with its own envelope. It's more difficult for the composer to use the system in that way. You have to specify 16 envelopes and the frequencies that you want for all the harmonics. We have some software called the Analysis Synthesis System that uses an A/D converter to analyse the power spectrum of any sound that's fed in through a microphone as it varies over time. In that way, the computer actually calculates the harmonics and their relative envelopes. That's a first step. The whole trick in the digital synthesizer business is to get the amount of information that the composer or performer has to specify to make a sound down to a small enough level so that he can actually sit down and make a sound in a reasonable amount of time, but still give him enough flexibility to control the texture of the sound over the range that he wants. As you know, sound that's made with a digital synthesizer, or a digital system in general, is created by producing samples of the wave form; and our particular system uses a variable sampling rate in which for each channel a new sample is generated between 30,000 and 60,000 times a second. So in any one second, there are between 30,000 and 60,000 numbers that specify the wave that's coming out of the channel. You can have the performer specify all 30,000 numbers and they can make any sound they want, that's for sure; literally any sound that you can use. Obviously, it's just not a useful system for generating music. It's a very delicate act of balancing how many controls the composer has to work with; and yet you've got to give him enough control to make a great variety of sounds. I think we have a very elegant balance of the two opposing forces in the Synclavier. Some people want to be able to do more things, but then other people have trouble working with it the way it is now.

**Synapse:** *How would you describe the difference between an analog and a digital synthesizer?*

**Jones:** That's a good point, and I'm sure there's a lot of confusion about that because I think digital has tended to become more or less a buzz word. A digital synthesizer is actually a small computer. In fact, some people's digital synthesizers are merely general purpose computers with high speed programs running in them. The way they

**“The limitations of the hardware itself are much different from the limitations of the one program that we have been running in the machine.”**

work is that the computer computes a picture of the wave that you want to produce. Let's take a speaker that's making a sound wave that a person is listening to. If you analyse the movement of the speaker cone, you'd have all the information to describe the sound that the speaker was generating. Let's say you measured the position of the speaker about 40,000 times per second. When there's no sound, the speaker's in the middle; then it goes out 100th of an inch, 200th of an inch and so forth. If you do this quantitatively, like let's say you measured the speaker's position to a resolution of a thousandth of an inch over a one inch trip, you could see where the speaker was 40,000 times a second. That's called sampling, and what you're doing is numerically recording. What you would be recording would be an actual picture of the sound wave. The way a digital synthesizer works is that it uses computer hardware to compute the numbers to give it the sound the performer wants. The composer specifies the sound in terms of frequency, harmonic spectrum, loudness and so forth; and so in terms of those parameters, the composer or performer can describe the sound to the computer, and the computer can turn around and calculate how the speaker must move to generate those types of sounds.

**Synapse:** *What has been the general reaction to the Synclavier?*

**Jones:** Well, actually there's quite a wide range of reaction depending on the outlook of the viewer. There are a surprising number of people in the music business who are really interested in computers, particularly in electronic music composition which is a very important, although not very large element of music, but it's a growing one. And in that group of people, there are many people who are just interested in the actual techniques for generating music; and a great deal of them can actually write computer programs and so forth, and compose music in that way. So that group of people is just fascinated by the fact that inside this one little box there's a very powerful computer and digital synthesizer and the whole works. So a lot of them are just swept up in the actual technology of the system itself. Now, the musicians themselves don't want to confuse their outlook with trying to get into the technology that actually makes the sound, which is great because when you become wrapped up in the technology that makes the sound, you tend to lose sight of the purely musical aspects of the sound being created; and you're always asking yourself, "Gee, how is that sound made?" And while it's fine to have some people who work in that mode, you want to try and keep the musician from having to worry about digital computers. Anyway, the

musicians first of all are almost universally impressed with the types of timbres that the digital synthesizer can make. It really offers a whole new set of sounds that analog synthesizers just haven't been producing in the past. This is mostly from the use of FM plus the use of the arbitrarily complex wave forms. But it's also from the fact that you do have a computer controlling the synthesizer, and the computer can go in there and change the parameters that affect the sound at a very high rate. In other words, you can have a one millisecond burst of this sound, followed by a one millisecond burst of a slightly different sound. The effect on the ears is just a burst of sound with a certain amount of complexity which is actually made up of many hundreds of little snippets of sounds that the computer has placed together very rapidly. So both from the fact that the digital synthesizer can actually compute different wave forms than analog synthesizers have been producing, and also

poser/performer to use; and the burden of taking that information and making sound is passed off on to the computer, which is the way it should be. This is possible because the language the composer uses to talk to the computer can be completely different from how the computer actually generates the sound. I mean, they're just great at sitting there and doing ugly computations, and the end result, of course, is fairly elegant music.

**Synapse:** *What do you feel the impact of digital synthesis will be on the commercial market?*

**Jones:** Boy, I wish I knew. As with anything new, there's a certain group that is out there aggressively pursuing it, but then there are those other ones who are hesitant to jump into a new field. So I don't know exactly how fast digital synthesizers will be appearing in the commercial world. But I think the driving function is pretty powerful in terms of the new types of sound that the digital synthesizer offers, plus the con-



PHOTOGRAPH BY BILL MATTHIAS

**Cameron Jones demonstrates the Synclavier. The computer, synthesizer and diskette system are housed in the box on the left.**

from the fact that the digital computer can control the digital synthesizer very rapidly, you just end up with a whole new library of sounds at your disposal. So that's one of the important things that virtually everyone catches on to right away. Secondly, is the compactness of the system. Big analog studios tend to have racks and racks of oscillators and amplifiers and envelope generators and so forth, whereas the actual hardware in the Synclavier is very much of a table top type unit. With the analog equipment you have to have all sorts of jacks to route signals, whereas in a digital system, the computer directs the flow of information between the different modules. So the whole control of the device is done by the computer.

**Synapse:** *What area of digital synthesis do you expect to see advancing in the near future?*

**Jones:** For the first time you can really do some development in the area of a means for control that is comfortable for the com-

trol the computer has over the sound; and also the speed at which you can actually get a digital system to make a specific sound is really quite rapid—and once you've developed the library of sound, you can immediately recall it. So you save a lot of time in terms of patching, and tuning, or goodies like that; so both from the timbre wealth available, and the actual effectiveness of the system in a commercial situation, there's a great deal of pressure to advance with the use of digital synthesis. I guess the only limiting factor is the expense, which is too bad; but, as with anything new, it's just a very complex piece of gear you have to provide.

**Synapse:** *Let me ask you what's next for New England Digital. Where do you go from here?*

**Jones:** Well, right now we manufacture computers, and we manufacture Synclaviers. It's going to be awhile before—well, let's speak business for a moment. Obviously, New England Digital's whole trip is manu-

facturing a unit that a lot of people are going to purchase and make music with. I mean, it's business, right? We've designed the Synclavier, and we've sold ten of them, and it's out there, and so we are in business right now with the Synclavier. Before we can say what other digital systems New England Digital might offer for sale, before we can specify what such a system looks like, we're going to have to wait awhile, quite awhile, to see what the reaction to the Synclavier is. I'm speaking of a good year to two; because one thing the company can't afford to do is go off and design something that isn't going to suitably fulfill a bunch of people's requirements. If you're a research institution funded by the government, that's the sort of luxury you can afford. Your sole task is to experiment with new designs; but unfortunately, or maybe fortunately, depending on how you look at it, we're in a position of designing an instrument that people can actually get a hold of and use effectively and productively in making music whether they're interested in electronic music composition, or more commercially oriented music. I think both aspects are handled admirably by the Synclavier. Electronic music composers immediately latch on to the capabilities that it offers, whereas the commercial musicians have to try and fit it into what they're doing now, and let's say what's hot on the commercial music now is funk. Well, those people are going to analyze the instrument in terms of its ability to produce funk; so one of these days digitally synthesized bells are going to be where it's at, at which time, there will be a run on the market, so to speak, for equipment that makes digitally synthesized bells. And pretty quick there will be bell buttons appearing on different models, right, which there sort of is now. Now, the Synclavier is a completely programmable system. You can write programs for it, we can write other programs for it; and so you can really tailor the system a great deal in terms of what the program is doing inside. So probably there'll be experimentation in that mode first; and there are some people who are doing that. Three of our customers are spending much more time implementing their own programs than they are using the existing system to actually make music. One of these is Joel

Chattaby at the State University of New York, and he has one of our systems, and he's implementing a language called "play." It's a typewritten language. And it's another whole mechanism for having the composer specify the sound he wants. So there will be work like that that I think will make the system available even though it's in the exact same hardware. It's the exact same computer and synthesizer and knobs and buttons and control panel and whatever; but the different versions of the software will make it functionally different to different people. So that's where the effort will be done first. A lot of people want a much lower cost model, and I can understand it. But the cost is not going to come down without reducing some of the capabilities that are there. For example, the first thing that you could chop off the Synclavier would be the diskette system, and you'd knock a couple of grand off the price; but then you wouldn't be able to record a sequence on the diskette. Maybe you could connect up a cassette recorder, but then it would be a little bit slower, and it wouldn't offer you the random access capability of the disc, and of course you wouldn't be able to write programs on a cassette-based system the way you can write computer programs on the diskette-based system.

**Synapse:** Do you expect any changes in the system as it stands? For instance, last night you were speaking of having the memory start to read at the first key depression.

**Jones:** Oh, I think there will be minor changes in the software which of course will become available to all the users who have purchased the system in the past. I don't contemplate any hardware changes, such as adding a whole new vibrato-type oscillator to the digital synthesizer to give you that one specific effect, because first of all, it would be incredibly expensive for New England Digital to redesign the circuit boards. That's just a fact of life. It's taken us many years to get where we are now, and so I think the hardware will stay exactly the way it is, and it's fine, because the hardware offers a great deal of potential. I think what will be done will be making changes in the programming of the system that make subtle steps towards making it more effective either in the commercial, or the compositional applications. ©

**Synapse**

**A Fabulous First:** Motion Detector ICs, converts motion to a voltage which triggers internal alarm circuitry. May be programmed for certain changes in light (motion). Includes on-chip musical sequence generator. .... **MDIC \$6.95**  
**Premium OP AMP!** BB-3500 from BURR-BROWN, features: LOW NOISE, DRIFT, LOW INPUT BIAS, 15 kHz, 20V P-P output (1v/uS slew rate), and more. Regularly sells for up to \$36.00 each! **Exclusive..... only 99c ea., 6/\$5.00**  
**Audio Synthesis Literature:** "Tech Notes" featuring circuits, ideas, new products, parts sources, construction aids, calibration methods & more. Our own R&D newsletter, 12 issues/\$17.50  
**Hybrid Active Filter:** identical to the AF-100-ICJ DIP Package. D.C. to 10 kHz, 4 onboard op amps, state-variable filter. Simult. HP, BP, LP & Notch outputs. .... **\$6.95 ea.**

**CFR ASSOCIATES**  
 Box F  
 Newton NH 03858

Add \$1.75 Shpg. & Hdlg. Write for FREE flyer.

**CINCINNATI  
 INDEPENDENT ELECTRONIC  
 MUSIC STUDIO**

**DEDICATED TO ELECTRONIC  
 MUSIC SERVICES AND SALES**

**David McClanahan, owner**  
 115 Calhoun Street  
 Cincinnati, Ohio 45219  
 (513) 281-9028

**EMS VOCODER 2000**  
 for the treatment  
 and modulation of human  
 speech and the production  
 of speech-like effects from  
 music or other sounds.  
 Used by radio, television,  
 studios, groups  
 and theatre.

**EMS VOCODER 2000**

**Electronic Music Studio Supplies**  
 5832 Westminister Avenue  
 Montreal  
 Quebec H4W 2J8

**Piano Center**  
 122 Rue de Paris  
 Montreuil 93100  
 Paris

**Zen On Music Co Ltd**  
 25 Higashi Gokencho  
 Shinjuku-Ku  
 Tokyo

**EMS West Germany**  
 7257 Ditzingen 3/Hiemeringden  
 Finkenstrasse 4  
 07152 - 53273

**"No  
 United States  
 agent yet."**

**EMS The Priority**  
 Great Milton  
 Oxford  
 08446 - 729

**EMS**  
 Electronic Music Studios

Don Preston was one of the earliest jazz/rock players to get behind the synthesizer. His style in those early days was to have its effect on many who heard him play. George Duke said in a *Synapse* interview that "... the guy that really first impressed me was Don Preston. I didn't know what that stuff was when I heard it on Frank Zappa's records. I said, 'man!'"

*Synapse* figured that anyone involved with synthesizers for so long would have some strong opinions on the subject. We were right.

---

by Doug Lynner

---

**Doug Lynner:** *What circumstances led to you becoming involved with synthesizers?*

**Don Preston:** I can't really say how I got involved in electronic music except that before I was into that, I was into "musique concrete." As far as playing, I had my own "acoustic synthesizer" consisting of what are now standard items, but at the time were quite unique: brake drums, drive shaft chimes, gongs, coiled springs and tuned leaf springs. I started a lot of things because I brought a lot of this junk with me on the road and people would see it, and then I started seeing other people using it. I built my first synthesizer myself in about 1967. It didn't have a keyboard or anything like that; it was just a pocket of tricks. I have many tapes of concerts during that time that were really interesting from an electronic music point of view, because a lot of the concerts that The Mothers did were not like any of the albums. We would play two or three vocals at the most, and the rest would all be bizarre music. I remember in 1960 I had a group, and we were improvising to films of microscopic light, as well as other images. My wife was an artist at that time and designed some slides that were not dissimilar to the light shows that came out in the late 60's. We were manipulating the slides in such a way that they moved and flowed with one another. We also did a lot of talking in the midst of our playing which was another thing that people started doing around the early '70's.

**Synapse:** *What do you mean?*

**Preston:** Just saying certain words. I even had a piece where we were just playing random notes; it was all improvised so it wasn't really random, but it was patterned after the random-type feeling. While we were doing that, this girl in the audience would start muttering to herself, "Stop

# Don Preston

playing that music, stop playing that music!" She would get louder and louder, and the louder she got, the louder we got. It was like a contest, until finally she'd be screaming at the top of her lungs, "Stop playing that music!", and then we would stop. Things like that.

**Synapse:** *What things in your development made that a logical step?*

**Preston:** I've thought about that. I really don't know, except that I can remember my father showing films, and he'd always be playing things like "The Rite of Spring," or "Concerto for Left Hand" by Ravel as a background, so my ears were kind of attuned to that. Then when I was stationed overseas in the Army, I became a member of a band in Italy. Herbie Mann was one of the guys in the band, and he helped me a lot—he

**"One of the main reasons for art is to help other people have the inspiration to reach the place where they can create something."**

used to beat me over the head with a saxophone so that I would play the right changes—and that was my first experience playing with anyone else. There was another guy in the band whose name is Buzz Gardner—he later became a member of The Mothers—and he really instructed me along a lot of lines. This was 1950, or '51, so you can imagine that things were just coming out. I wasn't really into "avant garde music" at that time, but what we were playing was pretty avant garde. I've always leaned towards anything that was new, I don't know why. I guess because I hate to listen to music when I already know what it is going to sound like. I've always had this theory that it's the advance of the technical part of music that is really what the music is all

about. It sounds kind of cold saying the technique is the most important thing; but it's not just the technique, it's the advancement of the technique and striving for new ideas. If music didn't advance, it wouldn't hold interest for me. The advancement is a real impetus for other people in other fields to advance their field whether it be science, architecture, or whatever.

**Synapse:** *Have you seen music having that kind of effect on other fields?*

**Preston:** Not directly, but I think indirectly it does. One of the main reasons for art is to help other people have the inspiration to reach the place where they can create something.

**Synapse:** *People know of you as playing on this or that album or tour, but they don't know of your own music, and I was wondering at this time what your directions are.*

**Preston:** Well, I'm really mixed up right now. I have a group co-authored by Arthur Barrow and myself, called Loose Connection, and that I consider my baby. It's a commercial venture for me in the sense that I'm trying to get a record deal. It's a jazz-rock group, sort of patterned after Weather Report, or something similar to that. We have a lot of good material together. Arthur is a wonderful writer and player, and Bruce Fowler is in the group; and Marty Jabar is playing percussion. The group is of such quality that I don't want to go out and do a bunch of little gigs with it unless it's just for the exercise. I don't want to do anything without a record deal because it doesn't really pay. If I can get a record deal, then I'll really put my energies behind it, if I can't, then I'll just drop it.

**Synapse:** *How heavily does the group and the music rely on electronics?*

**Preston:** Well, there are five synthesizers in the group, at least. Everybody plays Synthesizer, except the drummer, and we may branch out into that. It's heavily synthesizer oriented. Bruce has a Steiner—a big one. Marty is getting—he should be this week anyhow—the new Oberheim OB-1—what a great name. Arthur has the Serge stuff you saw, plus the Buchla. And I have a Moog Modular System, a Minimoog, and an ARP Omni; so that is quite a good array of synthesizers.

**Synapse:** *Is there any real viewpoint as to how the synthesizers are used musically?*

**Preston:** Well, as I said before, it's a commercial venture in the sense that it's not totally out. It's saleable. We still try to maintain integrity in the group as far as writing and quality. I've had so many rejects because we didn't play all funk, and that's basically the biggest criticism we've had so far. So that's one bit of integrity that we've managed to hold on to. I'm glad to play funk as much as anybody, but I'm not going to make the group a funk group and play simplistic music just for the sake of getting a record deal or selling the group.

**Synapse:** *What do you think it takes to be successful in getting a record contract?*

**Preston:** The people who work for record companies are terrified for their own income, because it's a known fact that those people get fired at the drop of a hat. One mistake, and they get fired, and then they go on to some other record company and they're terrified in that record company. For the most part, from the president on down, they're all terrified for their own jobs. So

**"Herbie Mann . . . helped me a lot—he used to beat me over the head with a saxophone so that I would play the right changes."**

when they listen to your music, they're all listening with a terrified ear, and if you don't have the most commercial thing in the world, they don't even want to hear it. I've heard music that sounded incredibly great—commercial, lyrics, production, everything—and they couldn't get near the front door. It's a very strange business. You really have to have a tremendous amount of luck, along with being a good musician and creator. If you have all the qualities that make good music, you still really have to have an "in", because there is so much competition it's unbelievable.

**Synapse:** *How do you think that atmosphere affects music making?*

**Preston:** It's horrible. It's horrible beyond belief because it stifles your very creative ability. L.A., for one thing, is the worst place. It may be better than some place in Arkansas, I don't know, but L.A. is the pits. The minute you land in L.A. you start thinking about commerciality because that is all that is available here. Where do you find anything good here? There's no dance here, there's no theatre—well, maybe there's a theatre company that does some good things but they're just a small starving

theatre company. There's no music. Where can you go and hear anything good musically? You can't, other than commercial jazz. You can hear that all day. In New York you can go out any night and see something that will just blow your mind. You can't find that in L.A. anyplace. And in the recording industry it's the same thing. You can't go anywhere with anything. I'm involved in another group with Buell Neidlinger, and if I took the music of that group to a record company, I'd be laughed out of the room. They would not even consider it. And it's a beautiful group.

**Synapse:** *What kinds of things do you think need to exist in this area for something to happen?*

**Preston:** I don't know. I think it's hopeless. I really do. I'm moving. I'm trying to go to New York just because there is nothing here for me. If I can get some other people to move there with me . . . I don't know. It all depends on a lot of things: whether I can buy this house and whether I can get some property in New York. I'm getting to a point right now where I have to do something. Here I have to take gigs with Leo Sayer. Not that I don't love Leo, he's a wonderful little guy, you know, but that's not really what I want to do.

**Synapse:** *Speaking of people like Leo Sayer, how do you feel about the uses of synthesizers within the context of popular music?*

**Preston:** Well, I must say that I resent it in a sense, because it's gotten to be such a cliché. Here I've invested all this money into electronic equipment and it turns out to be just a terrible cliché in the hands of people who are doing all of that stuff with pop groups. So the only thing I can do now is to avoid the synthesizer clichés that they've all set up, some of which I was learning long before they even used them. God, it's terrible. I've always tried to avoid being part of that community, and now I'm part of it whether I like it or not just because I have my life tied up in synthesizers.

**Synapse:** *What do you think might be the possible effects of technology's integration into music in a larger social and cultural context?*

**Preston:** I love that. I love that idea. It's science fiction. One thing I saw in Star Wars was that everyone had this familiarity with incredibly complex machines. They didn't bother explaining anything like they used to. They just said, "Oh, there's a computer," and they just operated the thing. It's just like today; if twenty years ago you'd have shown somebody a synthesizer, their mouths would have just hung open. And yet you take any keyboard player in any disco club, bowling alley or Holiday Inn, and man, they will walk right up and turn all those knobs and dials and know exactly what to do.

**Synapse:** *So do you think we have a situation where . . .*

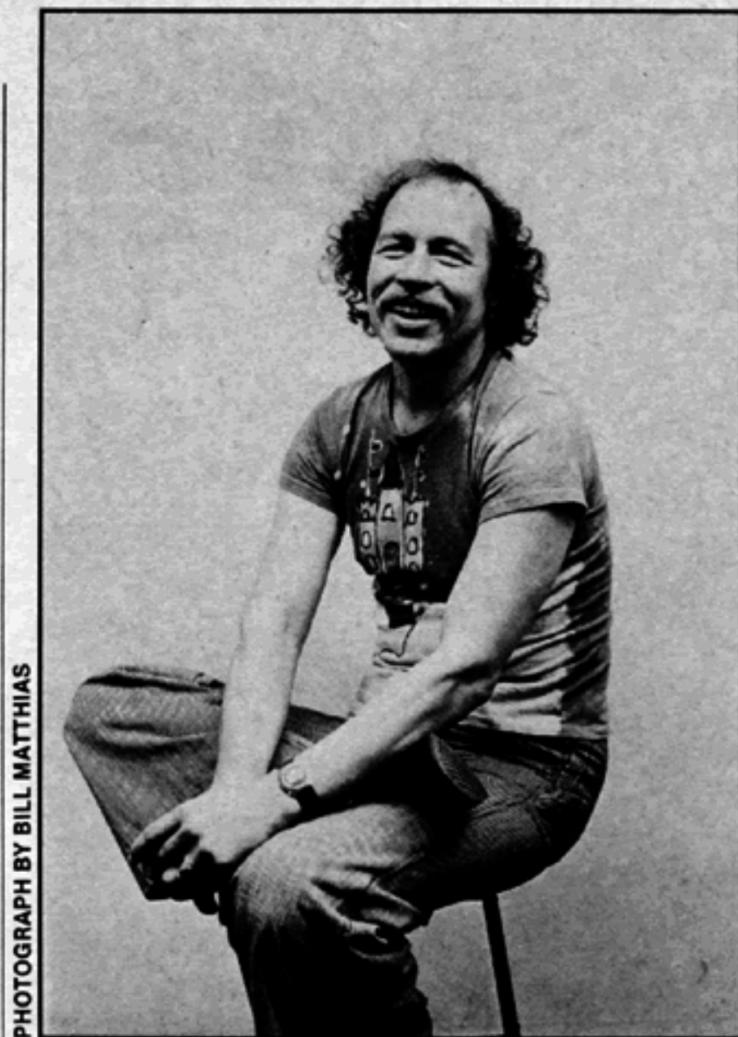

PHOTOGRAPH BY BILL MATTHIAS

**Preston:** It's becoming ingrained—right. I can see in another fifty years that everyone's DNA will be carrying synthesizer knowledge.

**Synapse:** *What do you see further on down the line when technology becomes part of our baggage? Where does it go from there?*

**Preston:** Well, I've speculated on that question somewhat, and it has always been a very hard question to answer. My position has always been not to think about it. Because then if you get to the place of doing what is next and you've already thought about it, you can't get into the space of just letting it happen. You can watch music progress in terms of the harmonic scale. Bach was great because he used a lot of diversity from the norm of the first few steps of the harmonic scale, whereas his contemporaries didn't get away from that. Then Beethoven got into 9ths and it just slowly progressed. Debussy was into 13ths and all kinds of strange harmonies, and Stravinsky carried it way beyond. It goes right up the harmonics of one note—each progression is the next step in the harmonic scale. And then they got into serial music. There wasn't anything left after they'd used all the notes available in the harmonic scale. Then Harry Partch came along and divided the scale into many intervals per octave and used many of the in-between notes that the ear could hear. Then I guess the next step was John Cage, who used random tones and random rhythms. That's the epitome of complexity as far as the technological development of music, because there is nothing more complex than randomness. Okay, so then where do we go from there? I guess the next place to go is into the spiritual—that's the only thing I can see. ☉

# Looking for an Electronic Music Class

by Rodney Oakes

Walk into any music store and you will probably find a synthesizer section. Watch any television show and you will hear electronic music integrated into the background score. Numerous commercials use electronically derived sounds to sell everything from groceries to automobiles. Almost every jazz and rock musician from Donna Summers to Frank Zappa toys with the electronic medium. Film composers rely heavily on electronic music and according to *Close Encounters of the Third Kind* we will all need to know the medium to communicate with extra-terrestrial beings. Where does one go to develop skills and discover the principles of creating in this new medium?

Historically, electronic music instruction has only been offered in a handful of prestigious universities. Usually, the prerequisites for working in these laboratories were rather rigid and limited to advanced composition students. But as the popularity of the electronic medium increases, there is a growing need for centers where musicians and enthusiasts can go to learn and develop skills. A background in electronic music is almost essential for the working musician. Many non-musicians would like to discover more about the production of electronic music just to enhance their own listening and aesthetic experiences. Fortunately, during the past decade there has been a proliferation of centers that are open to everyone, resulting partly from the increased popularity of the medium, and from the drop in the cost of equipment to a level affordable by smaller colleges and private studios.

Electronic music centers may be found in most large urban areas. Many private studios offer excellent courses with fine teachers, which are rather expensive. Although the tuition costs of these studios are reasonable considering the overhead costs to the owners, this expense may be too much for one's initial electronic music experience.

Another opportunity, frequently overlooked, exists at many local colleges. Across the country, colleges are increasingly offering courses in electronic music. Surprisingly, many of these courses are free or inexpensive, and are available to part-time students.

Gone are many of the roadblocks: admission to a program, prerequisites, and large tuition fees. Four year colleges and universities offer extension or community service courses in diverse fields, including electronic music. Each year the number of two year community colleges offering electronic music courses, with only a residency requirement for entrance, grows. Utilizing the offerings of a local college can be a viable solution to the aspiring synthesist.

Once an available program has been located, one should investigate the course carefully. There are certain outcomes that a student should expect from an electronic music course. The actual course content and procedures will vary according to the philosophy of a school or teacher, but it is reasonable to expect certain concepts to be developed, and experiences to be offered in any such course.

It is of the utmost importance that there be equipment available to work with. Creating in the electronic medium is similar to creating in any medium; one needs to practice. The degree of sophistication of the equipment is not as important as is its accessibility. Unfortunately, there is a current misconception that to create in the medium, one needs an extremely expensive, polyphonic, modular synthesizer and a twenty four-track studio. Such a studio might confuse a beginner more than help in the learning. A number of fine electronic music works have been created in studios with only a small synthesizers, and two or four tracks available. It is essential that a student be allowed to work with the equipment and experiment on his or her own. Obviously, while it would be impossible for any course to offer a synthesizer for each student, a strong program will schedule ample practice time.

The brand of equipment is not extremely important. Modular synthesizers are considered to be slower and more cumbersome to operate than non-modular synthesizers, but one can more easily conceptualize what one is doing with modular equipment. Modular synthesizers use patchcords for connecting modules and functions. As a result, following the patchcord visually may help in the understanding of the principles of voltage control, essential to the understanding of electronic music. Modular or non-modular, the available synthesizer should contain the following minimum functions: 1) three voltage controlled oscil-

lators, 2) one white noise generator, 3) one voltage controlled filter, 4) one voltage controlled amplifier, 5) two envelope generators, 6) one keyboard. Fortunately, once a particular synthesizer has been mastered, it is quite easy to understand another brand or design.

Adequate recording facilities, something that is difficult to define, are imperative. The minimal requirements would probably be two quarter-track stereo decks. Beyond that, almost any multi-track deck with one or more half-track and quarter-track decks would be considered desirable. A mixing board and quality speakers are also necessary. Other equipment that may be available could include spring or tape echo devices, digital delay, frequency shifters, frequency followers, ring modulators, and a variety of other processing devices. All of these extras will enhance the learning experience and the aesthetic outcome of the creative products.

Finding a college with a well equipped studio can be a pleasant surprise, although a number of colleges have developed very advanced laboratories with extremely sophisticated equipment. It is not unusual, especially in urban areas, to find a small college that has more than one synthesizer, both modular and non-modular, and multi-track recording facilities. In addition, most of these studios are equipped with one or more analog and digital sequencers and various processing devices.

As important as the equipment is to a program, the key element is probably the teacher. Teachers of electronic music are, for the most part, trained composers who have worked in the electronic medium. The teacher usually has a background that is heavily oriented towards art music combined with a knowledge of electronics, acoustics, and maybe some rock and jazz. Regardless of the teacher's background, most good ones are open minded and eager to work with all kinds of students. In initiating an electronic music program, the teacher has had to have been totally committed to bring the program into existence. In addition, this commitment most likely has included combating of prejudices from other faculty members and the convincing of administrators to spend large sums of money on a program that they do not understand. Consequently, if a teacher's aesthetics differs from the student's, one should not be too concerned; the many techniques and skills to be learned can be applied to any form or style.

A good course in electronic music should emphasize voltage control and its application to the synthesizer. The key to the mastery of any synthesizer is an understanding of voltage control and how this process is used to create desired aural effects. The synthesizer by definition is a voltage controlled instrument, and it is this aspect that differentiates it from acoustical and amplified instruments. A course in elec-

tronic music should present voltage control concepts through lectures, demonstrations, and readings, and should allow plenty of time to practice the application of these concepts.

Synthesizers still are most versatile in the recording medium where time and care may be taken to refine all of the desired effects. To fully realize this potential, recording techniques are an important part of any course. Basic concepts of line level recording, sound with sound, processing, splicing, and mixing techniques should be presented.

This does not mean to imply that a course should not offer the opportunity to explore live performance techniques. Once basic skills have been mastered, students should be encouraged to explore the infinite possibilities of the live performance experience. Performances with two or more synthesizers and/or amplified instruments can be very satisfying aesthetic experiences. In addition, live performance, although usually more limited in selections of sounds, allows the student the opportunity to develop ensemble performance skills, and creates an experience that is totally different from creating a prepared tape.

Educational courses sometimes offer students opportunities to write or realize electronic music for specific occasions: dance concerts, theatrical productions, educational radio or television, and multi-media events. Such experiences are invaluable to the participants. In addition, colleges have audiences who are excited to hear original, new music by local aspiring electronic music composers and performers.

Other important related areas that may or may not be included in a course are acoustics, compositional skills, and the history of electronic music. All of these can be extremely useful. A basic understanding of acoustics, the science of sound, is crucial to realizing the potential of any synthesizer. Compositional skills, depending on one's background, can be useful in organizing material. Novices frequently have an infinite number of ideas about what they would like to create, but because they lack compositional skills and experience, could profit from learning to work within limitations. The development of composition skills in the electronic medium does not mean that it is necessary to master the historical forms of music of the Western world. The most basic composition skill to be developed is the ability to organize desired aural effects in time. A good teacher can help students who have no musical background grasp the basic principles of repetition and contrast.

There are a number of good reasons for the serious student of electronic music to become familiar with its history. One of the most basic ones is to learn what has already worked successfully. There is nothing immoral about borrowing technical approaches from Ussachevsky, Subotnik, or



**Good news from EML**  
**SPECIAL PRICES**  
 Get more for your money. For a limited time we've reduced our prices on the board.  
**POLY-BOX**  
 Now add 26 additional pitch sources and a unique polyphonic capability to your synthesizer. Adapts to most synthesizers.  
**KITS FOR SYSTEM DESIGNERS**  
 Do it your way. Design a system that fulfills your own creative requirements. Complete instructions for special applications available.

Write or call today. **NOW CALL TOLL FREE 1-800-243-7270**

**EML** electronic music laboratories, inc. makers of ElectroComp Synthesizers  
 P.O. Box H, Vernon, CT 06066 • (203) 875-0751



**wavemaker 4**  
**integrated synthesizer**

... a complete, self-sufficient system offering the composer and performer an unmatched creative freedom and interactive capability.

Accurate signal and control generators, coupled with an unusually full complement of signal processors, afford the best features of flexible, high-cost modular facilities. At the same time, a comprehensive set of normalled connections, switched routing and mix/blend sub-systems for both signals and control sources yield the predictability and "ready-mix" properties of simpler hardwired units.

External source preamplifiers and input dynamic shaping functions, along with convenient routing controls, permit full use of the powerful processing section by external instruments alone or mixed with internal signals.

**find out more about it:**

**wavemakers**  
 kb electronic music instrumentation  
 p.o. box 27  
 edmonds, wa 98020  
 (206) 542-8041

For Immediate  
Delivery  
of  
audio accessories

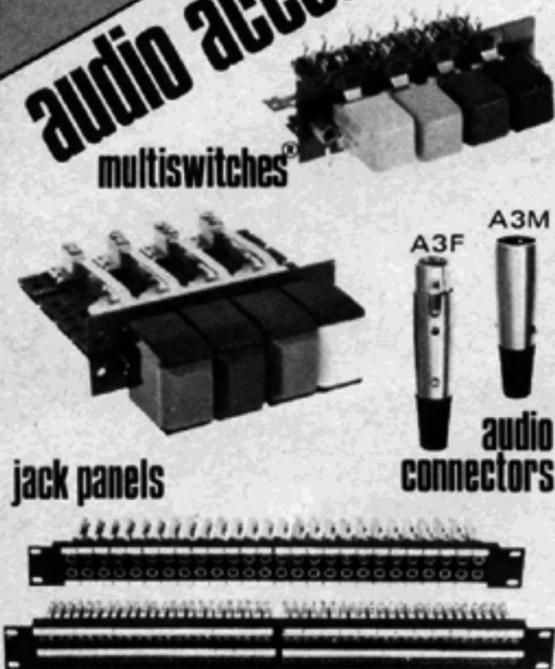

Send for our FREE CATALOG!



**CALIFORNIA SWITCH & SIGNAL**  
A complete line of audio accessories  
OEM Prices • Immediate Delivery  
13717 S. Normandie Ave., Gardena,  
California 90249 (213) 770-2330

**Take the trouble out of tuning**

Now, you can achieve instant, first-time, precision tuning of any instrument with the Korg tuner. Faster than stroboscopes or pitch pipes, it permits both audio and visual chromatic tuning. It's easy to use and operate, and enables you to correct pitch discrepancies with your eyes or ears. Suggested list price, \$159.95, includes tuner, batteries, AC adapter and handy carrying case.

**KORG** Another superstar of sound from Unicord.  
75 Frost Street, Westbury, N.Y. 11590

Stockhausen, anymore than there is in composing in traditional forms. Becoming familiar with the works of established electronic music composers permits one a wider choice in selecting one's own approach. Part of the process of developing a style is usually the imitation of other styles in the search for a personal aesthetic identity. A good class in electronic music should allow students a wide array of listening with an opportunity to follow the historical developments.

A lack of keyboard facility should not prevent one from exploring the electronic medium. Synthesizers are great equalizers. Many of the standard electronic works have been created without the use of a keyboard. A synthesizer allows one to explore timbre and, with knowledge and technical skills, it is possible to create interesting works utilizing just textures. Great variety may be obtained with the use of programmable keyboards or sequencers. Frequently, for some students, the concept of a keyboard interferes with the creative approach. Many fine keyboard musicians limit themselves by not being able to see possibilities beyond the keyboard. One continuously hears synthesizers used like organs. Keyboard facility obviously gives the synthesist more options, but lack of these skills should not prevent one from utilizing the medium.

There are many fine electronic courses that are not as comprehensive as the one described here. Hopefully, if you are planning on exploring the world of electronic music, you will look into many of the suggested areas on your own. You should be able, without too much effort, to find a college that offers a course in electronic music that satisfies your educational needs, economic situation, and is conveniently located. Contact the music department of the nearest college. If they do not already offer such a course to the community, they probably can refer you to a nearby school that does. ©

Synapse

**EXPAND YOUR SYNTHESIZER!**



**Control Application:**

- Mixer
- Oscillator
- Envelope Generator
- Envelope Follower
- Wave Form Modifier
- Gate Delay
- Level Indicator
- Portamento
- & Much, Much More!

**DENNIS 201 Control Voltage Processor**

Comes with detailed instructions.  
**ORDER NOW** at this special price! With power supply and mahogany cabinet: Only \$299.00. Catalog 25¢

**Dennis Electronic Music Co.**  
2130 Metcalf St. Honolulu, HI 96822

**LASER**

[From page 29]

mixture of helium and neon generates red light; argon generates green; krypton generates blue; and sodium generates yellow.

A crucial design feature of lasers is the inclusion of reflecting surfaces located just beyond both ends of the tube. The reflecting surfaces conserve the desired light wave energy, thus making it more available to stimulate atoms in the metastable state into emitting more radiation. In addition to conserving energy, the reflectors also enhance the spatial coherence of the light. When the single frequency waves of the laser bounce back and forth between two properly constructed reflecting surfaces, they quickly acquire a high degree of planarity, an attribute responsible for the concentrated nature of the laser beam. One of the reflectors is partially transparent so not all of the energy striking it is reflected. It serves as a window through which passes the radiated beam of laser light.

The scanning or deflection system is composed of galvanometers, transducers which receive electrical information and change it to mechanical information. Extending from each galvanometer is an arm to which is affixed a small lightweight mirror. The mirror rotates perpendicular to its axis according to the sub-audio and audio waves applied to the input of the galvanometers. The mounting for the scanning system orients the two mirrors for X Y deflection, one mirror for the horizontal axis and one for the vertical. The mirrors are positioned so that a laser beam striking the X-axis mirror is reflected onto the Y-axis mirror and out to a projection plane. An additional galvanometer may be used as a chopper to interrupt the beam before it becomes part of the X Y system. The chopper is a small flat plate with a one mm diameter aperture through which the laser beam passes. The aperture is opened and closed by a shutter attached to the arm of the galvanometer. The chopper can be used to blank the laser beam, to reduce the light intensity and to expand the range of light forms.

Since 1968, the best available scanning systems have been designed and manufactured by General Scanning, Inc. of Watertown, Massachusetts. They manufacture an extensive line of precision instruments that are small, durable, stable and capable of large angular excursions at relatively high frequencies. An extended frequency range is important, because the greater the frequency range, the greater the variety of available sculptural forms.

It is the nature of electro-mechanical systems to be non-linear, that is, for the output to reflect the system's distortion of the input. The scanners have natural resonant frequencies which intensify and modify any

Synapse

signals approaching those frequencies. For the purpose of composing laser light sculptures, the existence of resonant frequencies and other "distortions," such as overshooting and ringing, is highly desirable if they are considered additional variables in the design of forms. Overshoot and ringing occur because the scanning waveforms normally encountered require an instantaneous change from one stationary position to another. At audio frequencies, an electro-mechanical system can only approach linearity in that start-stop mode of movement. In addition, due to its inherent mass, the system's response accuracy falls off as the frequency increases; with increasing frequency, amplitude diminishes and complex waveshapes become sinusoidal until the point at which the waves disappear because the system no longer responds (about 8 KHz in the scanners G-0612 and G-108).

At the center of the sphere of the electronic arts is the notion of the synthesizer as a wave instrument, an instrument that generates, controls and transforms electrical waves in modes analogous to much that we know intuitively, psychologically and scientifically of the world of living phenomena. Harmonic forces, that is, periodic oscillations that have integral multiple relationships, give shape to our experience by providing easily recognizable references. The references are basic to the notions of ten-

sion, arrival and release which are fundamental to all dynamic art. The references are basic to growth, maturation and decay, fundamental processes for all living forms.

The recorded history of Western music informs us of the place of harmonic relationships in the progression of musical ideas, styles, instruments and temporal structures.

The human ear is capable of extremely fine pitch discrimination from 20 Hz to 20 KHz; and once a fundamental frequency is established, harmonic relationships create a powerful living system within that audio spectrum. Harmonic phenomena create areas of reinforcement, tension, anticipation, and resolution. In effect, the harmonic phenomena generate a set of conditions which provide openings for outside forces to come into play. Therein lies the power and charm of music and the electronic arts. The composer/performer is free to participate in the game of waves, the game of composing a hierarchy of perceptual functions and gravitational insistencies generated by harmonic phenomena.

The electronic art of light is rooted in the same field as the electronic art of sound, that is, the field of harmonic and dynamic wave transformational relationships. Since the graphic display for oscillographic mobiles and dynamic laser sculptures is based on X Y co-ordinates, a fantastic wealth of periodic interference forms remains to be

discovered. For every combination of frequency, amplitude, waveshape and the relationships of the rhythms of their respective changing states, a different visual form exists. Add to that every conceivable combination of ring, amplitude, waveshape and frequency modulation, and the range of forms increases considerably. Add to that a third dynamic wave train affecting the Z axis, i.e., intensity modulation, and the number of forms increases again; but what is of even greater importance than an increase in quantity is the introduction of another expressive control—the rhythmic play of pulse movement in a continuous range from points to broad bands of light and shadow within the forms. It should also be remembered that electro-mechanical systems, such as the galvanometers in the X Y laser scanning system, are characterised by idiosyncratic resonant frequencies which create additional sets of harmonic reference points.

The electronic arts of sound and light grow out of the same general approach to systems design. The basic system is a network of temporal events with a recognizable structure, a complex of interactive elements subject to individual changes and changing sets of relationships, an organization consisting of hierarchically and laterally related subsystems. The electronic arts are based on multi-dimensional systems undergoing dynamic and symbolically significant transformations. The patch or instrument design can be viewed as a collection of interrelated time functions operating on wave variables. From one perspective, each function has its own existence and its own time. From another perspective, the entire system constitutes an integrated whole with no separable elements. The time of the whole is of a higher order than the individual times of the elements.

There is no reason to expect instrument designs that produce desirable events in one sensory sphere to produce the same in another. Each receptor system and its associated memory evolved to respond to different ranges and temporal configurations of the vibrational spectrum. Yet to be formulated are the general principles of instrument design that will serve as a foundation for producing from a single patch equally desirable sound and light structures. Undoubtedly in the near future more composer/performers will concern themselves with the problems of uncovering and abstracting those general compositional principles. Because instrument design or programming requires logic, precision and analytical prowess, as well as a thorough understanding of the material and a clear idea of the nature of the design, the technical developments in programming and instrumentation will proceed in parallel with the increase in the theoretical knowledge of the art, with both developments being carried by the intuitive and practical aspects of the creative process. ©

Synapse

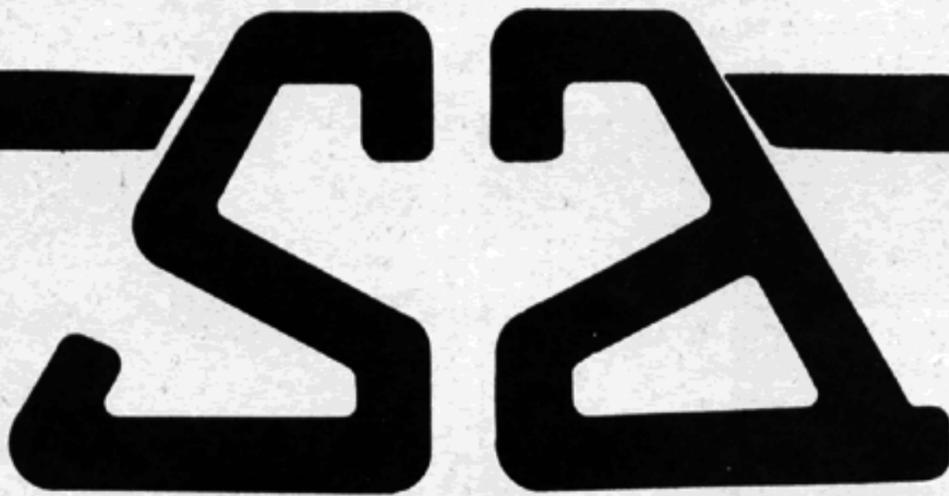

**ELECTRONIC MUSIC:  
IN-HOUSE PRODUCTION  
SCORING/ARRANGING  
RECORDING • RENTAL  
SALES • CONSULTATION  
INSTRUCTION • 2825  
HYANS ST. LOS ANGELES  
90026 • (213) 487-5148**

Sound Arts

Synapse

# On Keeping Score

by Robert A. Devoe

I remember vividly the shock waves that swept through the music world when John Cage first presented his "indeterminate" score to musicians to perform. His "chance" music consisted of several sheets of plastic randomly splattered with unconventional symbols. These were to be dropped on top of blank score paper and then to be interpreted as the musicians saw fit. That was back in the early Fifties when synthesizers were just a gleam in Robert Moog's eyes; band pass filters, audio generators and tape recorders were brand new toys for Edgard Varèse, and traditional music notation was just beginning to recover from the impact of the Schoenberg serialists. In my mind, that Cage score will always be symbolic of an opening gun in the revolution of the "New" music. While many of us were not always enamored of his results, his ideas and actions inspired us and gave us the courage to break the rules. Cage was saying something to us, something that has become the basis of much of my work ever since. I think he was saying these three things:

1. Anything can be a score.
2. Performing musicians are creative people, too.
3. Scores should be art.

I would like, therefore, to use those three principles as a framework for explaining how I go about "writing" my music.

## Anything can be a score.

Yes, some of us do *write* our music; but with a new language. I suppose every composer working with the new technology must re-define and re-invent notation. He needs to ask again what a score is for. Who is it for? I think a score should be more than a road map or a set of instructions for someone to follow. It should express a musical idea and convey the *sense* of that idea to a musical craftsman who will *use* it, not just follow it.

I believe a score should be a stimulant, a seed, a catalyst. It should trigger a creative process. The person executing the score should have the ability to *feel* the music in it. That's a special sixth sense that music

people have. It's an ability to hear music everywhere and in everything. Aural people are always listening. Street noises, children playing, construction; all are music. And for those of us who are really hooked into a music consciousness, all *visual* events are also *sonic* experiences. Sunshine streaming through trees is a chord; a foggy dawn has a sound. In my experience, it's almost as if a Hollywood composer had made a sound track for the world around me. I hear everything I see. Life is a score.

I was a painter before I was a composer, so such experiences are quite natural for me. I use to *listen* to my paintings. So you can see why I would subscribe wholeheartedly to the idea that anything can be a score. I'm sure that a good musical craftsman could produce fine music derived from a collage of torn posters on a Soho wall, a row of seagulls on a pier or even flyspecks on a screen. (FIG 1 & 2)

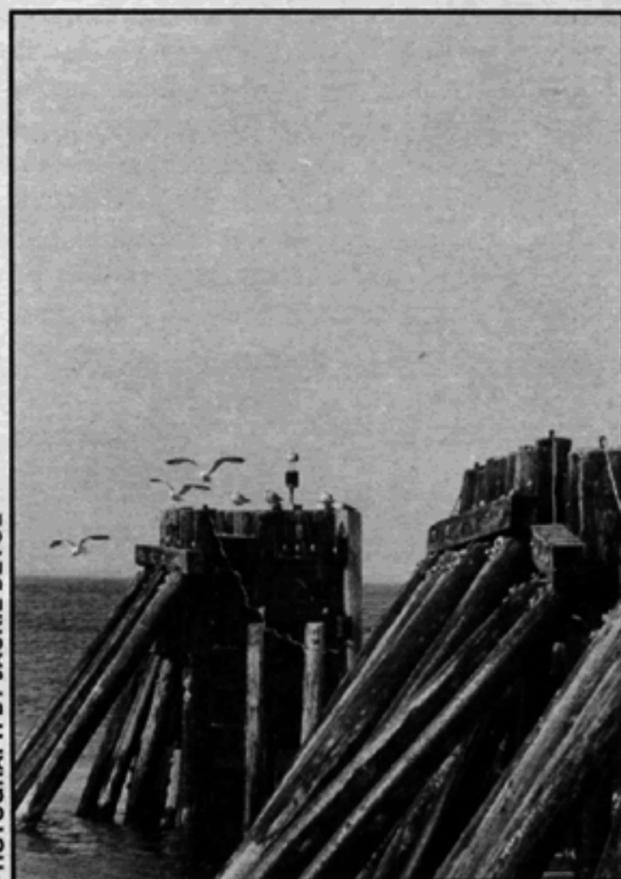

FIGURE ONE

Therefore, many of my scores do not look like scores in any ordinary sense of the word. I insist, however, that they are not just *pictures* of music. *They are assem-*

*blages of visualized sound.* I do not have a system of notation that I use like a dictionary. I create each score individually with whatever visual language I think is appropriate.

A lot depends on who I'm writing for; or to put it another way; how specifically I want to instruct a performer in the realization of my piece. If I am not just writing



PHOTOGRAPH BY JACKIE DEVOE

FIGURE TWO

to myself how much do I have to spell it out for someone else? How much freedom do I give to the interpreter? Which brings me to the second principle:

## Performing musicians are creative people, too.

Nowadays many composers produce their works directly on tape. Performing musicians, while used less, have a different role. They may enter the production during its formative time, and actively participate in the conception of the work. They usually play to a tape recorder instead of an audience, assembling a piece in small fragments rather than playing it. Thus a score is very often little more than a set

of sketches directed at the composer and his performing colleague, with no thought of its use as musical literature.

Perhaps there ought to be a new category of musician—something evolved out of the old concept of a conductor—a *soundsmith*, an audio craftsman who assembles music on tape. You hand him a score and he produces your work using the new technology. He would have to combine the talents of an electronic engineer along with fine musicianship; a special being to say the least. For such a person, a score should not be a paint-by-numbers set.

Traditional notation has evolved, as we all know, into a very precise language; so much so that performers are technicians charged with the task of rendering music note for note. While we expect every performer to "interpret" a work, such interpretation is severely limited involving minimal liberties taken with dynamics, tempo and expression. We tend to admire performers whose interpretation we believe is most faithful to the way in which the original composer might have done it. Thus, to be creative may be seen as a violation of the composer's precepts. The perfect performer, like the perfect loudspeaker, should neither add nor subtract anything from the music as it was written. That's tradition; but in the new music things are very different.

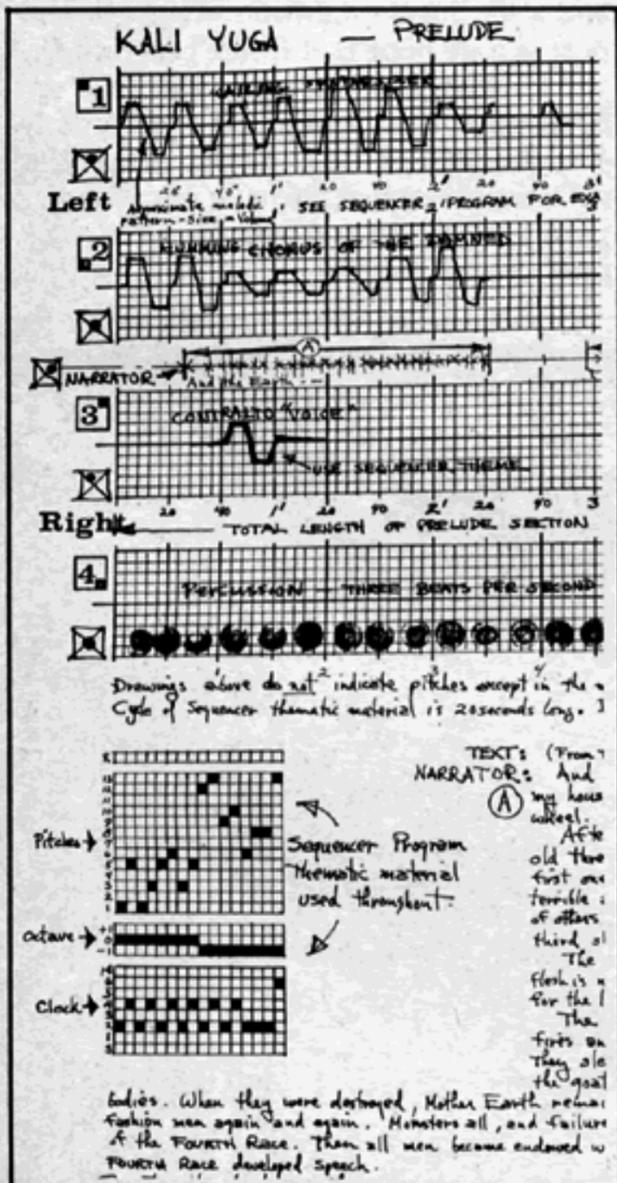

FIGURE THREE

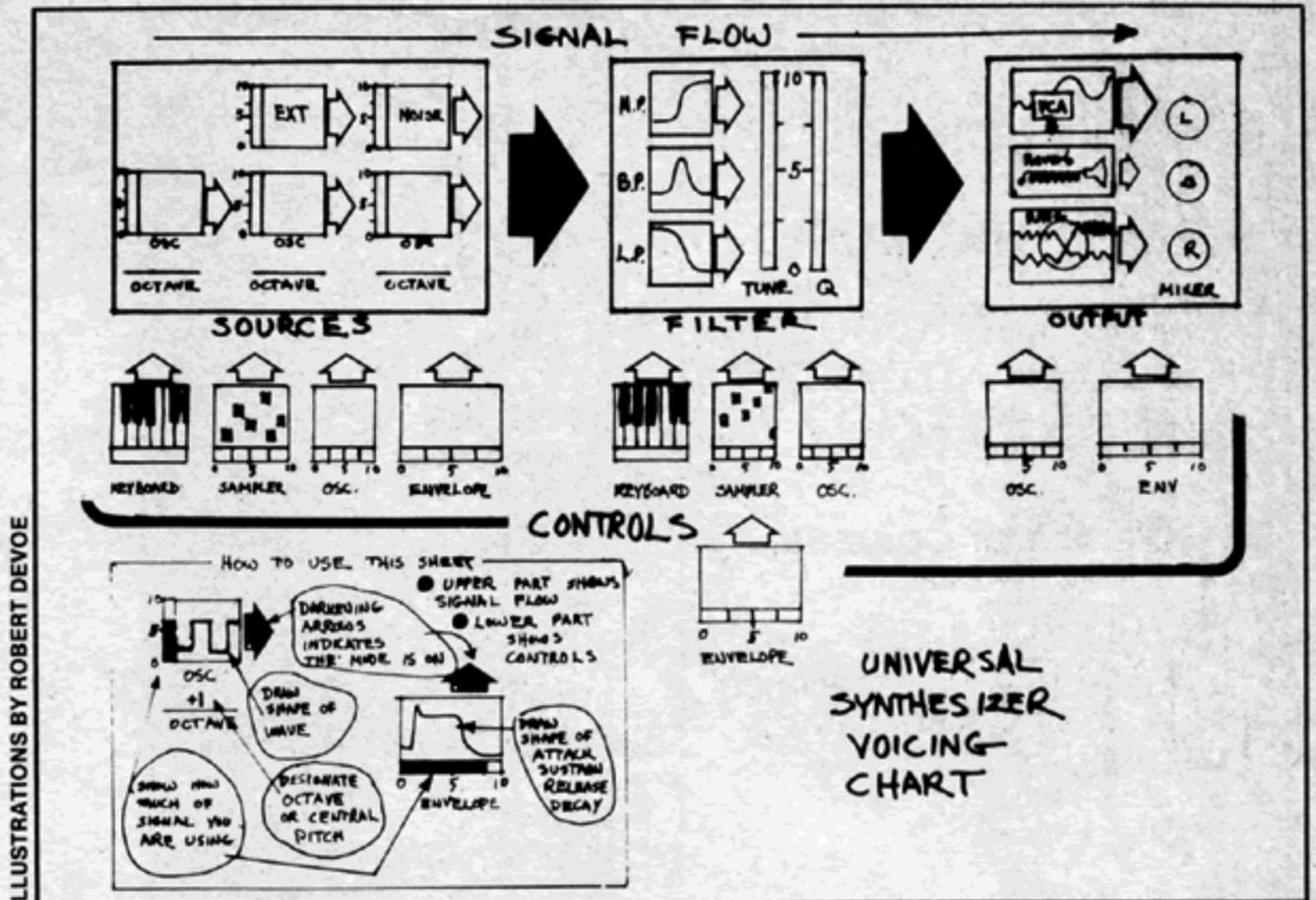

FIGURE FOUR

Good performing musicians are sensitive individuals who *comprehend* music. They hear the sounds of sunlight, the street music of life in the same way the composer does.

A number of instances are on record of people who experience what is called *synesthesia* or color hearing. Those who have this ability say they are able to see colors and abstract patterns while they are listening to music. Franz Liszt is credited with such pet phrases as "More pink here, if you please. That is too black. I want it all azure." Beethoven called B Minor the black key. Schubert likened E Minor "unto a maiden robed in white with a rose red bow on her breast." One Russian composer said, "Rimsky-Korsakoff and many of us in Russia have felt the connection between colors and sonorities. Surely for everybody sunlight is C Major and cold colors are Minors. And F sharp is decidedly strawberry red!" The point is; good musicians have integrated musical senses, aesthetic intuition; and we ought to trust them.

I suppose many composers think they're the only ones hearing that special inner music; that when we write a melodic figure, we assume we invented it; that it came from some source exclusively within ourselves. I don't agree with that. I'm a romantic mystic. I believe that those special melodies I find inside my head are not mine at all. They come from some universal repertoire of music, a bank from which we make withdrawals. Other musicians use the same bank, the same bank, the same currency. We don't have to spell it out for them.

I prefer to hand them a kit of parts, a series of modules and sketches which they may assemble for a variety of possible

results. There is no single right answer to the questions posed by my score. Your interpretation will—and should—differ from mine. For example; in my Kali Yuga score, (Fig. 3) I present the "reader" with a melodic figure, (notated for sequencer) and a very generalized pictorial description of its manipulation within a context.

Thus, with each score I must decide how much I will prescribe and how much I will allocate to the audio craftsman, the *soundsmith*. I often prescribe a specific synthesizer patch and define a melodic figure. Then I give only a very general picture of the total conception. To do more than that would be to hobble the soundsmith. By the way, most synthesizers use a few fairly standard patching systems to produce different voices. The patch diagram in Figure 4 is one I have developed to cover most conditions and relate to most synthesizers.



## THE AUTHOR

### Scores should be art.

Finally, I insist that the score has to be art. There is an old adage among musicians that if the music manuscript *looks* good it will probably *sound* good. This certainly proves true when you look at some of the

**THE  
BOSTON SCHOOL  
OF  
ELECTRONIC MUSIC**

**FOUR SEMESTER PROGRAM  
OF ANALOG AND DIGITAL  
AUDIO SYNTHESIS**

**First Semester Courses:**

- INTRODUCTORY AUDIO SYNTHESIS
- MUSIC THEORY
- INTRODUCTORY ELECTRONICS
- PREPARATORY LOGIC AND MATH
- SURVEY OF ELECTRONIC MUSIC

**THE  
BOSTON SCHOOL  
OF  
ELECTRONIC MUSIC**

28 HIGHGATE, ALLSTON, MA.  
02134 (617) 782-9100

**THE LIVE ONE**

The 63-note, **microprocessor-controlled digital sequencer** with all the features you need for **live performance**:

- TEMPO control with flashing LED metronome
- Single-step or continuous record/playback
- Step counter display
- PAUSE on note or STOP at end of playback
- FORWARD/REVERSE playback
- Interface to all popular synthesizers
- No-frills Price: \$450 Retail List

**THE MICROSEQUENCER**

For specs and dealer info, write:



**STRIDER  
SYSTEMS, INC.**

P. O. BOX 2934  
NORMAN, OK 73070

Makers of Advanced  
Electronic Music Instruments

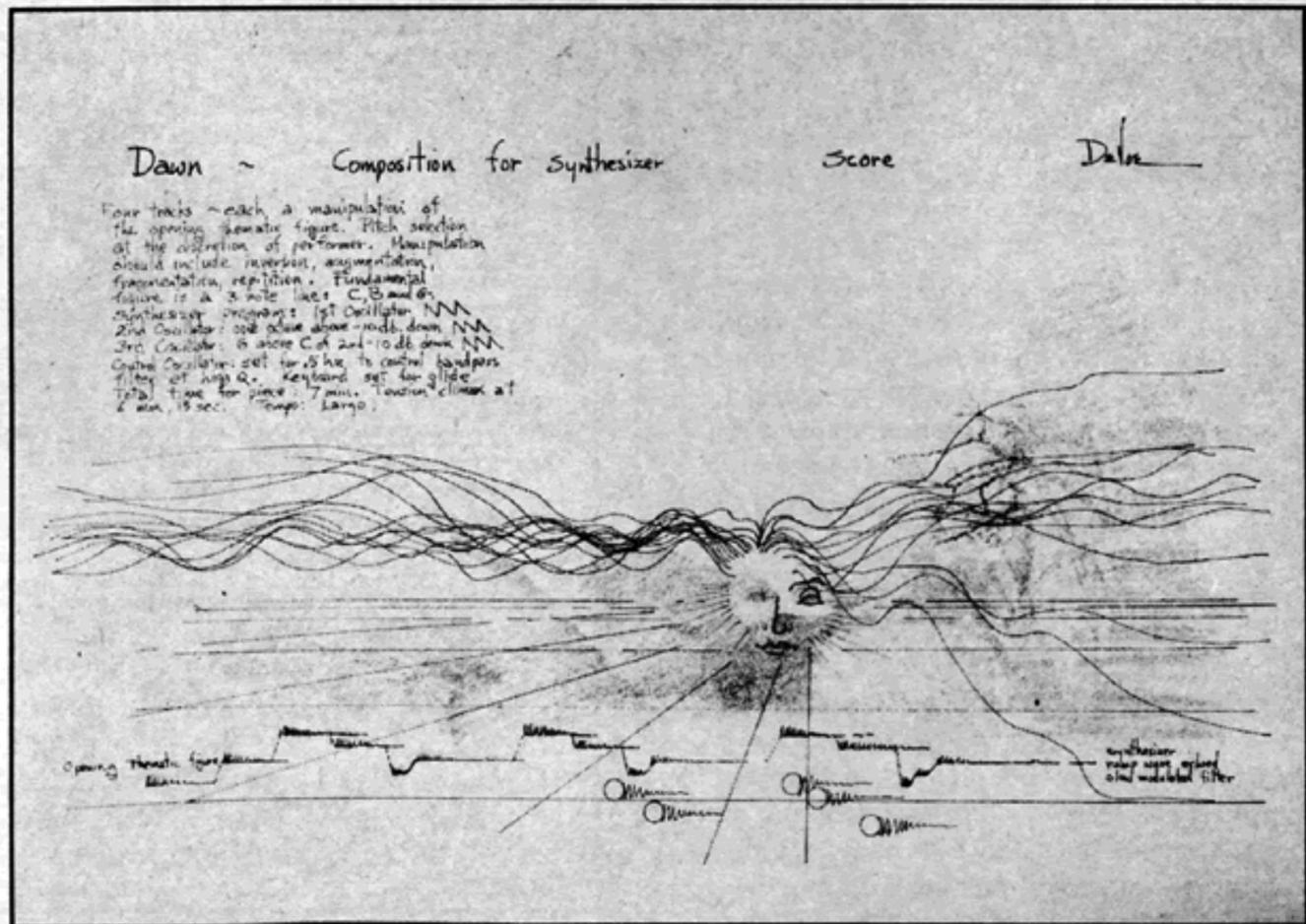

**FIGURE FIVE**

scores of the great composers; Bach, Beethoven, Mozart, etc. Their deft calligraphy communicates a gift for design, a sense of visual order which corresponds with the musical order they have conceived. Such scores should be, and often are, framed and viewed as art in museums. Modern music has produced some outstanding notation art. The sketches by Varèse for *Ionization* and *Poème Electronique* are cases in point.

My own scores, *Dawn* and *Vision*, are obviously intended to be art. They are complete on one page as shown here. (Fig. 5 & 6) No effort has been made to give specific pitch designations or even precise

patching instructions. Therefore, many renditions may be produced from them; all different. The possibilities are limitless, depending only upon the imaginative craftsmen who read them creatively.

One thing seems certain to me; the art of musical notation has not been made obsolete by the new technology. It is alive and well, thriving newborn with new purpose. I only hope that future generations will look upon my scores and those of my contemporaries, as products of an orderly evolution out of the traditions of the classical composers; that we have something worth preserving and performing as our predecessors did. ©

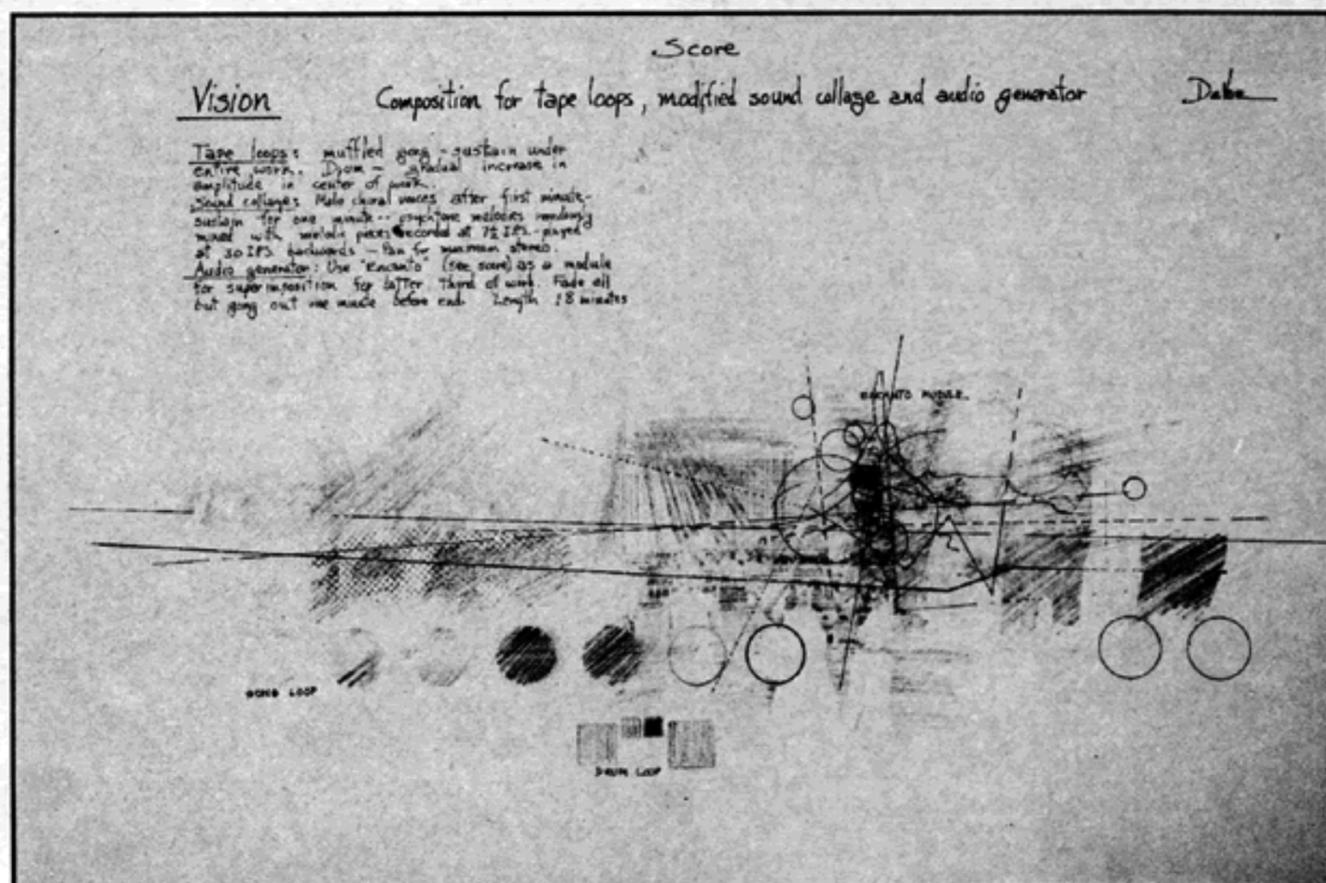

**FIGURE SIX**

# String Synthesizers Can Be: Just strings...

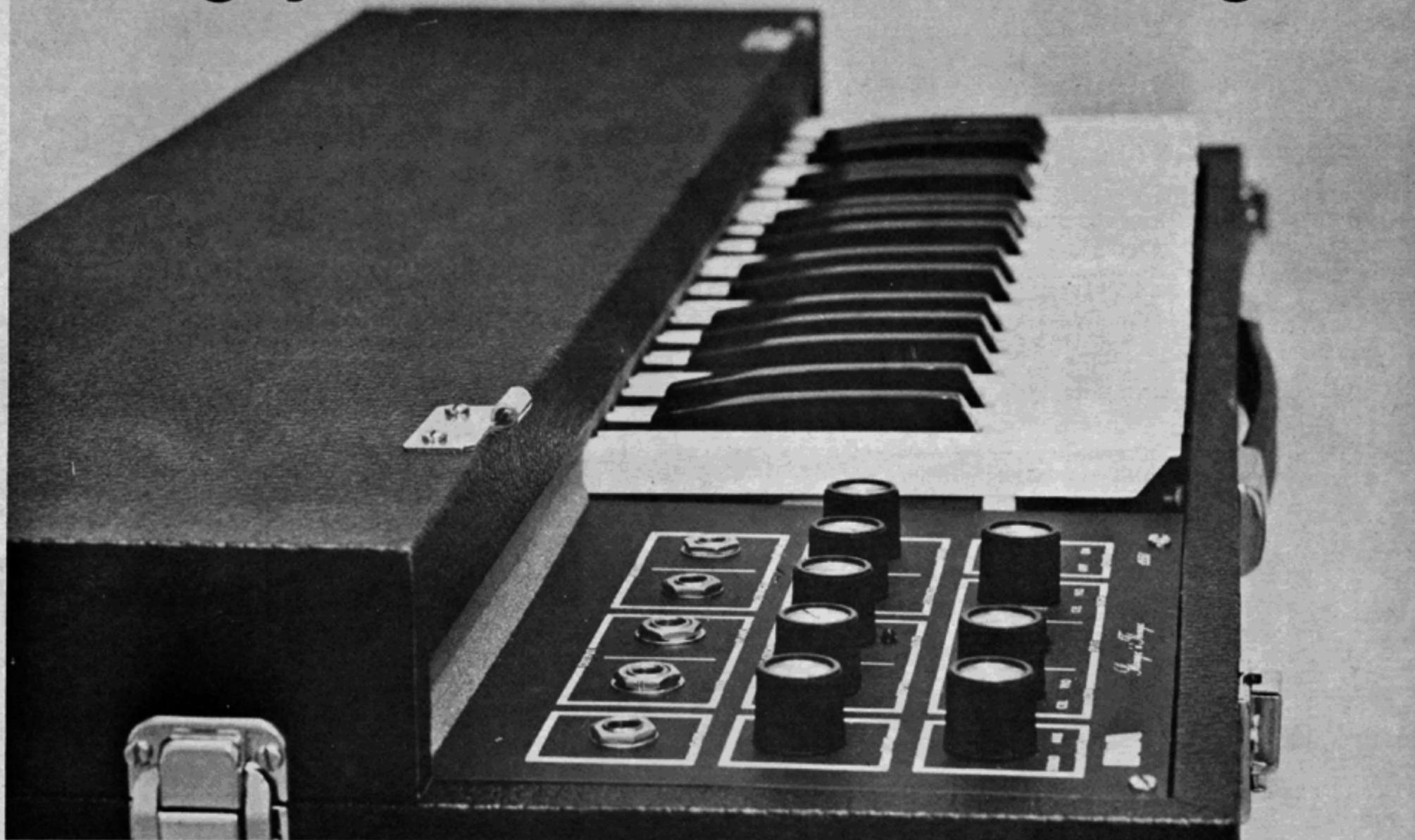

....OR they can have: violins/cello/piano, separate mixable piano output, synthesizer interface, variable chorusing, variable sustain controls, jacks for foot controls, keyboard split, dual violin/cello mixers, stereo string option, even a modestly priced computer interface option.

**You're gonna love it!**

*Stringz 'n' Thingz* just \$295 from **PAIA**

## TELL ME MORE

Send FREE CATALOG featuring this and other PAIA Kits.

Send Assembly and Using Manual for  
STRINGZ 'N' THINGZ ( \$5.00 enclosed )

name: \_\_\_\_\_

You've said enough, send complete kit for  
STRINGZ 'N' THINGZ ( \$295.00 enclosed )

address: \_\_\_\_\_

-shipped freight collect-

city: \_\_\_\_\_ state: \_\_\_\_\_ zip: \_\_\_\_\_

**PAIA**  
ELECTRONICS

DEPT. 2-S, 1020 W. Wilshire Blvd., Oklahoma City, OK 73116 (405) 843-9626



## Sequential Circuits Prophet

Of the several polyphonic, performance oriented synthesizers on the market today, the Prophet, recently developed by Sequential Circuits, has a definite niche, both in capability and price. In the manufacturer's battle over "how many variable functions (can be included) for an affordable price," this instrument may be leading.

The Prophet 5 was designed by Dave Smith (President of Sequential Circuits), utilizing integrated circuits for oscillators, filters, and envelopes (all from Emu), and a Z80 micro-processor/computer to program the entire face of the instrument. There is a five octave keyboard, pitch bend and modulation wheels, a master tuning control which functions even when the instrument is in a pre-set mode, pedal inputs for filter and loudness, as well as 40 potential program pre-sets. The entire face of the instrument is programmable: waveform select,

each voice will have the same timbre and envelope characteristic. Five keys can be depressed at any time. A sixth or more key will "borrow" from the first note played. Thus the keyboard will generally look at the last five notes to have been depressed.

**ADVANTAGES.** The primary advantage of this instrument is that, for me, it sounds good. In several months of sessions and performance, the instrument has never failed to get a positive response in regard to its sound. The four-pole Emu Lowpass filters undoubtedly have something to do with this. Final output summing also appears to have been well handled.

The second primary advantage with the Prophet is that it has been beautifully designed to be logical and fast for performance of most electronic music needs.

A third advantage with the Prophet, is that it is a synthesizer—not a hybrid organ. Several waveforms are available on the Low Frequency Oscillator, as well as frequency modulation of oscillator one with oscillator two at audio or low frequency. There are a good number of control voltage routing possibilities, all programmable. One example: synchronizing oscillator one with oscillator two, and utilizing the filter envelope to control oscillator one, creates some interesting and popular flanging effects for every voice articulation. A five voice thunder patch is interesting as well. The synthesist will find new effects (especially huge gongs and textures) available by depressing multiple keys and being conscious of orchestrational/harmonic tradition. These considerations have otherwise been available only on

changes could be generated. A third disadvantage rests with the inability to balance voices. This is a problem with virtually all polyphonic synthesizers today, even those with separate gain controls for each voice. In the middle of performance one cannot reset the final output balance, lest the next program be totally out of control. But with all voices at equal volume, a strong bass line is often lost to its accompaniment. A fourth disadvantage is the lack of touch sensitivity for controlling articulation, loudness, or timbre. But the raise in price to accomplish this particular addition would probably be as much a disadvantage as not having this potential. Oh yes, a fifth disadvantage—the audio frequency modulation of oscillator one with two cannot be held amplitude constant. That is, they won't track. A pity.

**COMPARISON.** Does this instrument knock all the others out of the running? Answer: no. This instrument will hold its own place for a great many musical applications. Independent timbres between voices and keyboard divisions are still the domain of Oberheim. The Yamaha CS-80 has touch sensitivity which of course, the Prophet does not. However, the Yamaha lacks the quickly obtainable programming—in both quantity and flexibility. The PolyMoog has its degree of keyboard velocity sensitivity, a few (factory pre-set) programs, and a good deal of balance-timbre control. It does not offer the multitude of programmable control functions which the Prophet will. With all of the instruments on the market, there are different approaches, and different styles of performance will draw musicians to each of these different instruments.

There will definitely be a great many new entrants into the polyphonic synthesizer market in the near future. The Prophet 5 is setting the way. At a retail price of just under \$4,000.00 it will hold its own for some time.

—Dan Wyman



PHOTOGRAPH BY BILL MATTHIAS

### The five voice programmable Prophet. Above, a control panel close-up.

modular synthesizers at great time expense. The Prophet is a fine commercial orchestrator's tool. For many elements of contemporary art music as well, the instrument has fine potential.

**DISADVANTAGES.** There are several disadvantages to the Prophet, most of them perhaps unavoidable. First, only five voice instruments are currently in production. Most keyboard players would like to play with more than five total fingers—at least on occasion. We have been told that a ten voice instrument may be available some time in the future. Second, while there are many inputs accessible through the back of the instrument (inputs for sequencer, filter pedal, volume, etc.), no sequencer or switching is possible to alternate between the different programs. This is too bad. The instrument could really add something to the novel effects world if rhythmic program

This is an instrument one can simply plug in, and play. A self-tuning system puts all ten oscillators in tune with each other. Master tuning is always available to transpose a part, or bring the instrument into tune with an ensemble. Programs can be instantly recalled or set. With forty positions available, there is room to log an interesting sound into the memory, go on to work at hand, and go back to the original at a later date, editing or modification being possible at any time. Incidentally, LED's always indicate what basic elements are in operation for any particular program.

frequency, filter settings, envelopes (4-stage type!), type of modulation, modulation routing, cross modulation, and even the volume/balance of the signal sources. A program "edit" circuit is included which allows for update, or modification of any settings which have been placed into the memory, without disturbing or having to reset any other values. The Prophet has a "non-volatile" memory insuring retention of the programs, even when the instrument has been shut off.

There are two oscillators and/or noise available for each "voice". The same program is applied simultaneously to all 5 voices, so

## Star Synare 3

The Synare 3 is another drum synthesizer of the type that is



PHOTOGRAPH BY BILL MATTHIAS

**Synare 3's can be set up in drum-kit form.**

becoming popular on recordings these days. Like the Syndrum previously reviewed here, the Synare 3 is designed for the percussionist with little knowledge of synthesizers.

The Synare is equipped with a basic array of controls and signal routing paths enabling the user quick and easy access to any of its limited range of sounds. The controls are conveniently mounted and, with the exception of the slide switches on the oscillators, easy to use, especially while playing the rest of a drum set with one hand.

Star Instruments has come up with an ingenious method for powering the Synare 3. The twin 9 volt batteries are actuated by the striking of the drum and are shut off after the decay of the sound. This results in a cordless, 1 piece unit with a long useful life between battery changes. This also makes the Synare very quiet.

The drum head of the Synare 3 is the same spongy material that is used on the Synares 1 and 2; not as fast as a tight snare drum,

but as responsive as any other percussion/synthesizer interface. The "head" is coupled to a speaker, which puts out voltages proportional to the intensity with which the head is struck. This signal triggers the two envelope generators and controls their peak voltage levels which are then fed to the filter and VCA.

And that's about it. Neither oscillator can be controlled except by hand. The VCF may be controlled by the above mentioned envelope generator, or by utilizing oscillator 2. Resonating the filter is the only way to get a sine wave from the Synare, so this becomes its most useful module. But without VCO's, more elaborate patching alternatives, and without voltage outputs to connect it to a real synthesizer, the Synare 3 becomes not much more than a toy. However, the Syndrum doesn't do much more than the Synare, and at half the price (\$199.00 per drum), the Synare 3 is a better buy.

—Danny Sofer

## Octave Cat SRM

The Cat SRM as a performance instrument has distinct advantages over other synthesizers in its category and price range. The basic set up consisting of two VCO's, two transient generators (envelope generators), one LFO, a three octave keyboard, and a low pass filter fulfills the requirements which are now considered stan-

dard for a good performance synthesizer. Special features however, distinguish the Cat SRM from others with similar functions.

Pitch bending is accomplished by the use of a slide with a notch at the center to denote the original starting point, and this method is extremely easy to use. The slide has a one octave range in either direction and tracks evenly.

The Cat SRM features a keyboard control switch with three possible settings. The polyphonic setting allows the performer to play two notes at once, and this leads to another interesting feature. In other two-note synthesizers, the S&H circuit activated by the keyboard samples two notes, but only holds one. The S&H on the Cat samples two and holds two. Execution is a bit tricky however, and an even two note sustain demands that the lower note be released last.

The second setting for the keyboard control switch releases VCO 1 from keyboard control. The mono setting changes the keyboard to monophonic for clean articulation of quick passages without losing that fat two oscillator sound.

And speaking of fat sound, this one's got it. VCO 2 has two different wave shape sliders—sawtooth and square—plus a sub-octave square wave slide, all of which can be used in various combinations. VCO 1 has sawtooth, sub-octave, square and triangle wave shape sliders, with the addition of a pulse slide which works in conjunction with a pulse

widthknob, allowing for richer timbres.

Frequency modulation by the LFO is operated by either of two knobs in the VCO 1 and VCO 2 areas. This arrangement does not solve the perennial problem of how to get FM quickly where, for instance, vibrato is desired in specific spots. This is the one weak point of the Cat, and of other synthesizers with a similar set up. However, there are some compensations. For those moments where there is no time to grab for the modulation knob, there is an LFO delay switch which will bring in the desired vibrato with a delay time of up to



**The Cat SRM: Cost effective.**

five seconds. But one of the most significant features of the Cat is the LED located next to the LFO slider. The idea has been around on modular units for so long, and is so simple, one wonders why no one else has come out with it on a performance instrument up till now. The LED blinks at the rate of frequency of the LFO, which

[Continued on page 49]

## Synapse

### Advertising Index

Ampeg.....	19	New England Digital Corp.....	Inside Front Cover
Analog/Digital Associates.....	14	Oberheim Electronics.....	Back Inside Cover
ARP.....	Back Cover	PAIA Electronics, Inc.....	43
Boston School of Electronic Music.....	42	Polyphony Magazine.....	18
California Switch & Signal.....	38	Roland Corp.....	8
CFR Associates.....	33	Sequential Circuits.....	15
Cincinnati Independent Electronic Music Studios.....	33	Serge Modular Music Systems.....	16
Dennis Electronics.....	38	Sound Arts.....	39
EML.....	37	Sound Sales.....	20
EMS.....	33	Strider Systems.....	42
Ken Schaffer Group.....	12, 13	360 Systems.....	10
Keystone Junior College.....	45	Voyager Keyboard Systems.....	24
Korg/Unicord.....	7, 38	Wave Makers.....	37
Micor.....	17	Yamaha International Corp.....	5

**MUSIC & MIME**

**THEATRE SCHOOL**

**July 23 - August 12, 1978**

Three-week residential program  
Pa.'s Endless Mountains  
Professional Classes  
In Electronic Music

Write today for free brochure  
**KEYSTONE JUNIOR COLLEGE**  
La Plume, Pa. 18440  
717/945-5141

# GUITAR SYNTHESIS

How can I extend the range of sounds I get on my guitar to be more expressive? What are the underlying concepts of electronic synthesis? What types of synthesizer systems are available to guitarists, and how do they work? These are questions many guitarists have asked in the search for new and dynamic means of expression. This is the first in a series of articles exploring the alternatives available to the guitarist who wants to get into synthesis.

A basic concept of synthesis unknown to the average guitarist is that of voltage control. Voltage control is the means of changing musical parameters in a synthesizer. On a keyboard synthesizer, pitch is one example of this function, because each key when pressed produces a unique voltage level that corresponds to the desired pitch. The pitch is created by a voltage controlled oscillator (VCO), the most basic component or module of a synthesizer.

In generalizing the concept of voltage control, the first twist is that voltages may change other musical parameters as well as pitch. A ready example would be the use of a rising and falling voltage to sweep a filter. In this case, the parameter changed is harmonic content, or relative "brightness." A filter of this type is called a voltage controlled filter (VCF), and is also a basic synthesizer module. Similar devices have actually been packaged independently in foot boxes using many names, among them the Mutron III and Doctor Q.

The third basic device on any

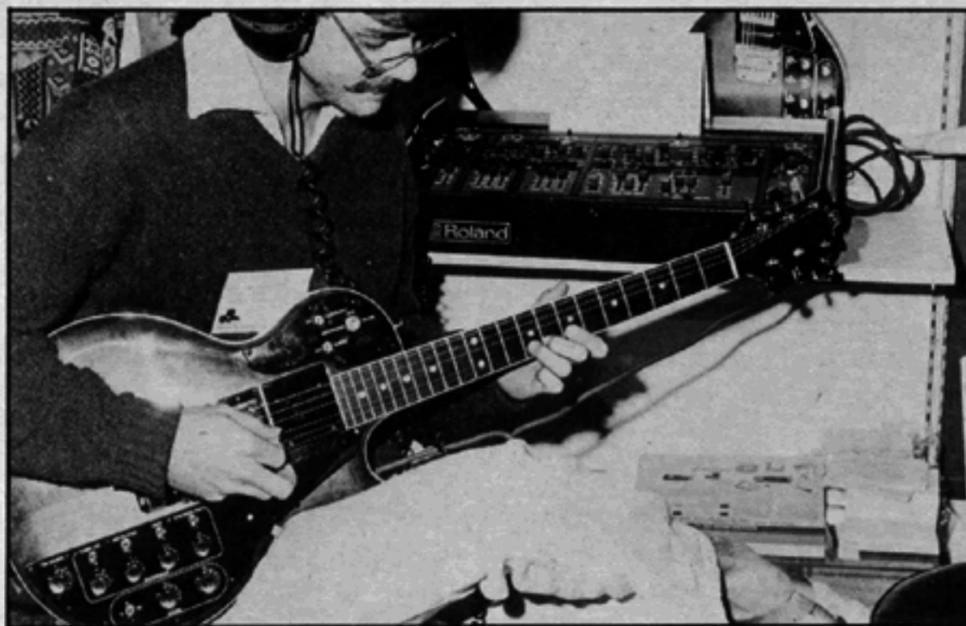

PHOTOGRAPH BY BILL MATTHIAS

## The Roland GR-500.

synthesizer is the voltage controlled amplifier (VCA). It "shapes" the amplitude of the synthesized sound according to the contour of the voltage controlling it. This contour, or "envelope," is variable and can be imposed on any given sound to produce varying results. For example, the envelopes of more conventional instruments can be imitated. Likewise, the sound of a tape recorded instrument played backwards can be produced.

The voltages used to control these and other modules are generated by other synthesizer modules such as the keyboard, envelope generator (ADSR, AR, etc.) and low frequency oscillator (LFO). These modules will be better understood by following the events that occur in a typical patch when a note is played on a keyboard synthesizer.

When a key is pressed, three signals (in this example) are generated. One is the pitch voltage

that tells the VCO the frequency to create. The second is the trigger, a high voltage of short duration, which tells the synthesizer that a new note has been played. Finally, the gate is generated. The gate is a signal that remains "on" as long as the key is pressed and returns to "off" when the key is released.

The trigger and gate signals are sent to an envelope generator. The trigger causes the envelope generator to begin forming a voltage contour. This contour is formed by adjusting the segments of the envelope, of which there are usually four. They are: "attack", "decay", "sustain" and "release", hence the name ADSR to describe the envelope. Each segment may be adjusted independently with a potentiometer. The attack segment determines the time it takes for the voltage generated by the ADSR to rise from zero to its maximum level. Decay specifies the time it takes for the voltage to fall from the maximum level to the sustain level. The sustain level is maintained as long as the gate signal is on (the key is pressed), while release denotes the time it takes for the voltage to return to zero after the gate has turned off (the key has been released). This creates one entire envelope whose voltage may be applied both to the VCA and the VCF. They may also be controlled by separate envelope generators.

Thus a typical patch on a keyboard synthesizer would run as follows: a pitch voltage is sent from the keyboard to control the pitch of the VCO. The signal of the VCO is then routed to the VCF where the ADSR controls the modification of its harmonic

content. From there the modified signal goes to the VCA where the same ADSR shapes the amplitude of the total signal.

The keyboard in the preceding example functions as a controller. It supplies the synthesizer with the information necessary to generate the desired sound. Any instrument can be used as a synthesizer controller provided it supplies the same information (pitch voltage, trigger and gate). The job of translating what is played on the instrument into synthesizer language is performed by an interface. There can be several approaches to interfacing an instrument. In the case of the guitar, two general methods are used on commercially available guitar synthesizers.

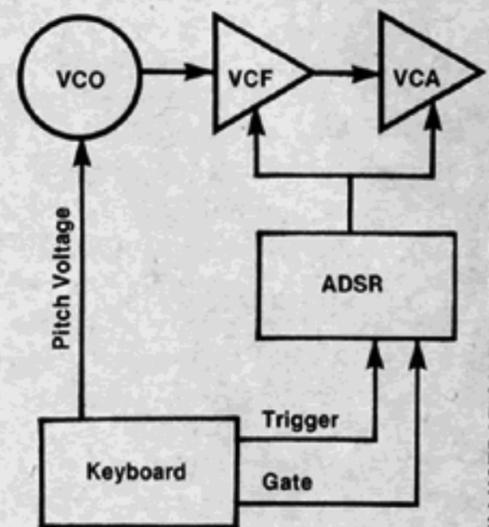
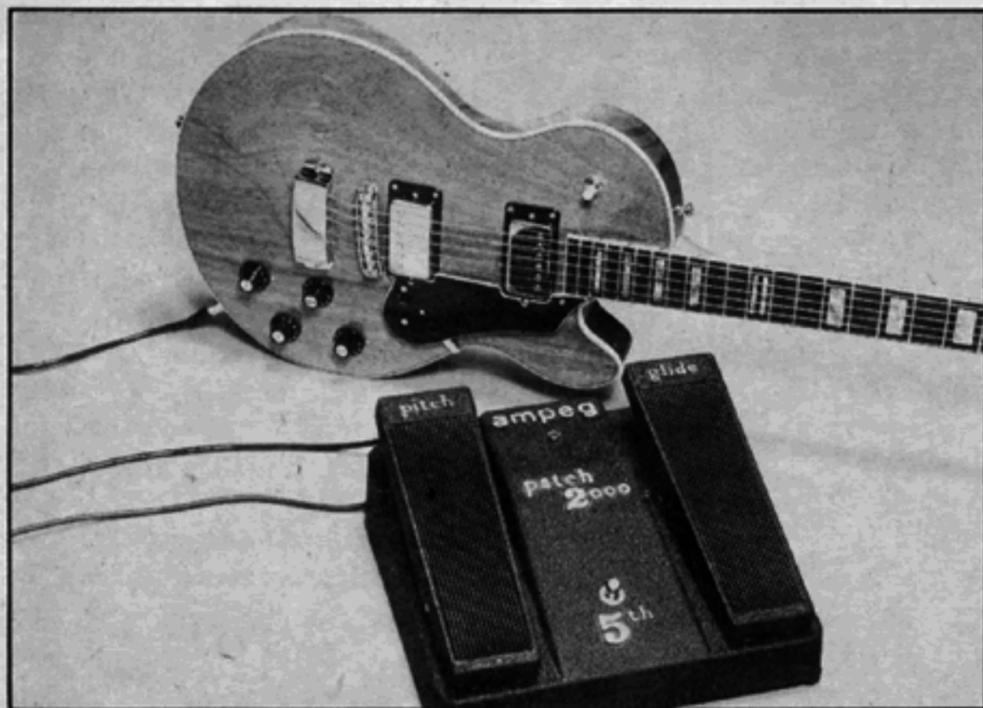

ILLUSTRATION BY SUE DENIM

## Basic synthesizer patch as described in text.

One method of deriving this information is to use the contact of the string with the fret to create both pitch and timing information. This is known as the wired fret method. In such a system, each fret is connected separately to the interface circuitry so that the pitch can be determined according to which fret is being played. The two manufacturers utilizing the wired fret method, Ampeg and MCI, solve the problem in two different ways.

Ampeg uses an insulating bridge and tailpiece, thereby enabling the interface to determine which string is making contact. This system is monophonic, i.e., it synthesizes only one note at a time. If more than one string is fretted, it selects the lowest of these strings for the synthesized note. If more than one fret is in contact with the string, the highest is chosen. A trigger is generated when a new note is fretted, pro-



The Patch 2000 with fret wired Hagstrom guitar.



The ARP Avatar.

Right, the 360 Systems Slavedriver.



vided this takes place on the lowest string in contact with the frets. If more than one string is fretted and the lowest string is unfretted, the new lower string is chosen for the pitch and a new trigger is generated. In the latest version, a trigger may also be generated without refretting by picking the selected string. The gate remains high as long as any string is making fret contact.

MCI uses a different method for determining which string is making fret contact. In their system, each fret is divided into six segments, each one being centered under its associated string. These "mini-frets" are wired separately to the interface. As long as the string is not bent past its own mini-fret, the interface knows which string to play.

As with the Ampeg system, the highest fret in contact with a particular string is chosen. A trigger is generated when a new pitch is selected and the gate remains on as long as a string is fretted. Picking will not cause new triggers in the current version. The unit is essentially monophonic, selecting the highest note fretted for the synthesized note and trigger generation. A second pitch may also be played, that of the lowest note fretted. However, this note does not generate its own gate and trigger.

Since the wired fret systems sense fretted notes only, the open strings may not be synthesized. Also, string bends are not followed, and non-standard guitar tuning cannot be used since the actual pitch of the vibrating string does not influence the synthesized pitch. Transposition is possible however, as it is with any guitar synthesizer. A pitch bending pedal may therefore be used to simulate string bends. (A pedal is provided with the Ampeg unit.)

The most widely used approach to guitar/synthesizer interfacing is pitch to voltage conversion, also

known as frequency following. This method derives the pitch played on the guitar by examining the actual guitar signal. Typically, the time it takes to complete a full cycle of string vibration is measured. This can be practically accomplished only if the vibration of each string is analyzed separately. Special pickups must therefore be used which provide a separate output for each string. Such pickups are generally described as "hexaphonic". They vary in design, principle of operation and the ease with which they may be installed on an existing guitar. Units using the pitch following approach are manufactured by 360 Systems, ARP, Roland, Holt Electro-Acoustic Research (H.E.A.R.) and various custom systems manufacturers. The only polyphonic system available on a non-custom basis is the Zetaphon, manufactured by H.E.A.R. The rest are monophonic, using the last note picked for the synthesized tone.

Triggers are generated by a circuit which detects sudden level change in the selected string signal, since this is the most straight forward evidence that a new note has been picked. The gate is turned on as long as that same signal is strong enough to provide usable information to the pitch following circuitry, since a weak signal has inherent noise which interferes with the pitch following process. Therefore, a trigger is generated when a string is picked and the gate remains on until the string vibration is stopped by the player or dies out on its own.

Existing systems follow this procedure with the exception that many delay the actual trigger supplied to the synthesizer until the interface has made a successful pitch estimate. This may take a cycle or two of string vibration, resulting in a noticeable delay for the lowest notes on the guitar.

Pitch following systems share

the ability to follow string bends, non-standard tunings, and play any note on the guitar, unlike the wired fret systems. Transposition is also possible. Existing systems also provide circuitry which derives control voltage from the loudness of the guitar signal. This additional control voltage may be used to control the VCA or VCF.

A technique used to expand the capabilities of guitar synthesizers is to modify the guitar signal and mix it in with the synthesized signal. Because a VCO is not used to generate the musical tone, transposition is not possible. A common form of modification is called "hexaphonic fuzz". This is similar to conventional "fuzz" except that the signal from each string is distorted individually (a possibility if a hexaphonic pick up is used). This provides the same kind of harmonically rich tone as a regular fuzz box, but the use of separate distortion channels permits the player to play chords without the muddiness present in conventional fuzzing. The Roland, ARP, and H.E.A.R. units have this feature.

Another modifier is the octave divider which processes the guitar signal to obtain a tone an octave

below the original. Like fuzz, this process requires a hexaphonic pickup to work well. It is included on the Roland in a monophonic form in which the same string selected for the synthesizer is modified. The effect is called "bass". Other common modifications are accomplished by sending the guitar signal, or hexaphonically fuzzed guitar signal, through the VCF which is triggered by the synthesizer trigger.

It is possible to produce many synthesizer-like effects by using modification techniques only. In fact, earlier Roland units (serial No.'s below 661000) used a selected string fuzzed guitar signal for the "solo voice" instead of the VCO output now used. As in current units, a pitch follower was included, but it could only be used to control an external synthesizer.

This column has presented the two basic methods of interfacing used in current guitar synthesizers. Future articles will take a more in depth approach, examining specific systems and interviewing artists who have had experience working with them.

— Doug Lynner & Ernie Perevoski

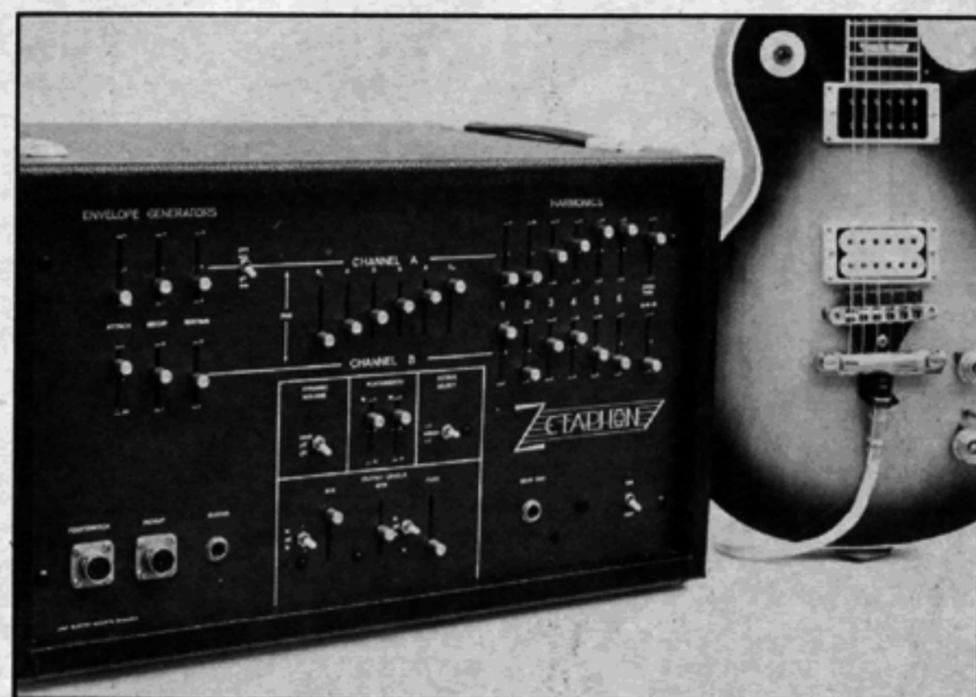

The Zetaphon by HEAR.

## Computer Controlled Triggers & Gates

In a synthesizer, there are two basic groups of signals: audio and control. The truth of the preceding statement can be debated from black to white with all shades of grey in between. Some synthesizers are constructed so that control signals cannot physically be plugged into audio inputs and vice versa. This certainly makes the difference apparent. Other synthesizers blur the issue by making inputs and outputs physically and electrically compatible. In this case, the worst that can happen with a cross connection is a disappointing nothing. In a computer-synthesizer interconnection, the two groups tend to overlap in their methods of generation and detection.

For the most part, a computer uses a D/A converter to generate audio signals such as sine, sawtooth and more complex wave forms. The computer reads these same wave forms with the use of an A/D converter. D/A and A/D converters are also used for generating and reading the DC, or low frequency control voltages which control VCA's, VCF's, and VCO's. Converters are necessary because the computer works in the digital domain, and the synthesizer in the analog.

There are however, two types of control signals which need not be translated into the analog domain for use by the synthesizer because even in the synthesizer they are digital. These signals are the gate and the trigger. A gate signal is one which initiates an event, allows it to proceed for a length of time, and then terminates it. The gate determines all phases of the event: the start, the duration and the end. A trigger only marks the beginning of an event and leaves the duration and end for another function to determine. Figure 1 shows a trigger and a gate controlling an envelope generator. Note that the width of the envelope in the case of the trigger is variable and

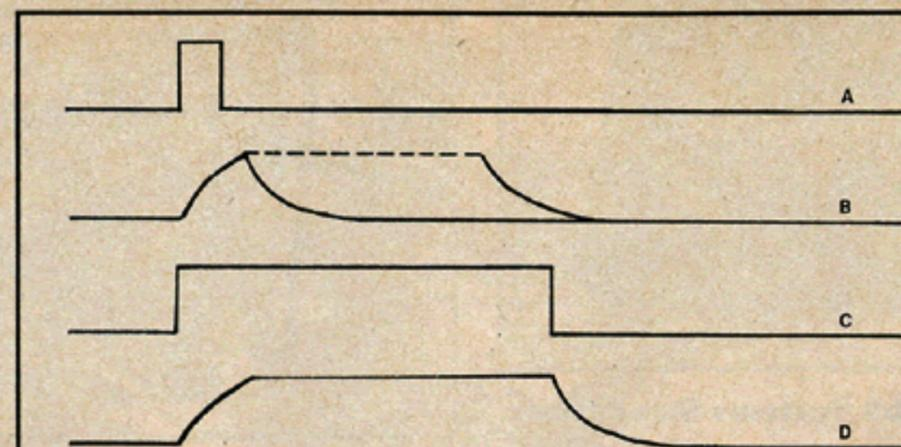

Figure 1: Trigger and Response (A&B) Gate and Response (C&D)

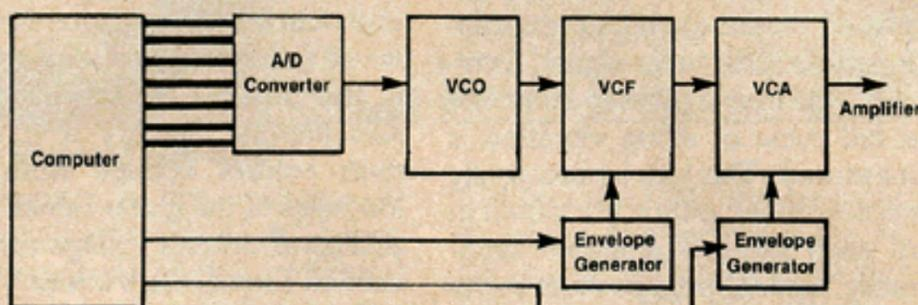

Figure 3: Typical Single Voice Synthesizer-Computer Interconnection

not dependent on the trigger pulse width. Electronically, a trigger and a gate are represented by a voltage pulse. The actual voltage polarities and levels vary from synthesizer to synthesizer. In all cases, one particular voltage is the no-trigger, no-gate state; and another voltage is the active state where a trigger or gate takes place.

A trigger has fixed pulse width. This width is determined by the reaction time of the electronics which are being triggered. A very narrow trigger pulse might be missed and the device might not be triggered. A gate has a pulse width which is variable. The length of time it is active determines the length of the event it is controlling.

The definition of trigger and gate relates well to digital concepts. A no-gate or no-trigger state could correspond to the binary number zero. A gate or a trigger state could correspond to the binary number one. Using these definitions, a computer could gate and trigger envelope generators and other functions by simply outputting a series of ones and zeros. These individual output signals from the computer, which are connected to the gate and trigger inputs of various synthesizer functions, differ from the binary words outputted and inputted from A/D and D/A converters in that they are independent of all other signals. These

individual signal lines are called *flags*. Internal to the computer, a series of flags may be lumped together to form a digital word, and may be manipulated by the computer as a word; but externally they are considered independent and can be set to one or zero at any time.

To a computer, there is little difference between generating a flag for a trigger and generating one for a gate. A computer acts at a rate much faster than the fastest timing necessary for either type of signal; so the computer must set the flag or trigger active, then wait around for the active period to pass and then reset it to its inactive state. In the case of the trigger, the active waiting time is fixed. With a gate it is variable.

Inside the computer, there are many different ways to implement the waiting function, but the most common one is some sort of counting sequence. When the computer reaches a point where a gate or trigger is to be generated, it will set a binary counter to a predetermined number.

A binary counter is a set of binary storage elements (flip flops) which are arranged to count either up or down each time a pulse is received. The pulse in this case is the master oscillator which synchronizes the computer and causes it to function. The number which is loaded into the binary counter is determined by

two factors: the first is the frequency of the master oscillator and the second is the length of time the trigger or gate is to be active. If the master oscillator is going at 1 MHz and the trigger active time is a quarter of a second (250ms) then the binary counter must be able to count to 250,000. As soon as the counter has been loaded by the computer, the gate or trigger is set. Then the computer decrements the counter by one and checks to see if it is zero. If it is not, the computer decrements it again, etc.

A typical flow chart of such a program is shown in Figure 2. When the counter is finally at zero, the decrementing is stopped and the gate or trigger is reset.

Computer control of the gates and triggers, along with the ability to generate analog control voltages with A/D converters is all that is needed to control all of the elements in a typical signal chain of an analog synthesizer. Figure 3 shows such a set up. The computer generates a binary number which is converted to an analog voltage for control of the VCO frequency. The trigger output controls the envelope generator for the VCF, and the gate output controls the envelope generator for the VCA. In writing a program for such a setup, the parameter list for each note to be played would include frequency, duration and timing.

—Pete Hillen

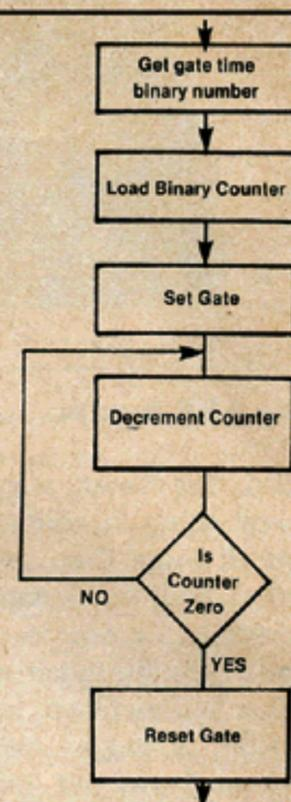

Figure 2: Typical gate counter program flow.

ILLUSTRATION BY SUE DENNIM

# LISTINGS

## Synthesizer Manufacturers

Advanced Tools for the Arts, P.O. Box 825, Tempe, Ariz. 85281 □ **Aries Music Inc.**, P.O. Box 3065, Salem, Mass. 01970 □ **ARP Instruments, Inc.**, 45 Hartwell Ave., Lexington, Mass. 02173 □ **Audio Arts, Inc.**, 5615 Melrose Ave., Hollywood, Cal. 90038 □ **Blacet Music Research**, 18405 Old Monte Rio Rd., Guerneville, CA 95446 □ **Buchla**, Box 5051, Berkeley, Calif. 94705 □ **CFR Associates\***, Box F, Newton, N.H. 03858 □ **Computone Inc./Lyricon**, P.O. Box 433, Norwell, Mass. 02061 □ **Concert Company\*\***, 3318 Platt Avenue, Lynwood, Calif. 90262 □ **Dataton AB**, Box 257, 2-581 02 Linköping, Sweden □ **DBL Electronics**, 83 Morgan Circle, Amherst, Mass. 01002 □ **Dennis (Electronic Music Components)** 2130 Metcalf, Honolulu, Hawaii 96822 □ **Electrux**, P.O. Box 149, Tarzana, California 91356 □ **Electron Farm/Harvest**, Gregory Kramer, 135 W. Broadway, New York, N.Y. 10013 □ **Electronic Music Laboratories**, P.O. Box H. Vernon, Conn. 06066 □ **Electronic Music Studios**, The Priory, Great Milton, Oxford, England □ **E-mu Systems**, 3046 Scott Blvd., Santa Clara, Calif. 95050 □ **Farfisa**, 1330 Mark St., Elk Grove Village, Ill. 60007 □ **Galaxy Systems**, P.O. Box 2475, Woodland Hills, Cal. 91364 □ **Gentle Electric**, 140 Oxford Way, Santa Cruz, Cal. 95060 □ **HEAR**, 1122 University Ave., Berkeley, CA 94702 □ **Heuristics, Inc.**, 900 N. San Antonio Rd., Los Altos, Cal. 94022 □ **Inner Space Electronics**, Box 308, Berkeley, Cal. 94701\* □ **Ionic Industries**, 128 James St., Morristown, NJ 07960 □ **Korg/Unicord**, 75 Frost Street, Westbury, N.Y. 11590 □ **Logistics**, Box 9970, Marina Del Rey, Cal. 90291 □ **MCI, Inc.**, 7400 Imperial Dr., Box 8053, Waco, TX 76710 (817) 772-4450 □ **Media Mix**, 4060 Stanford, Dallas, Texas 75225 □ **Micor**, P.O. Box 20885, Phoenix, AZ 85038 (602) 273-4111 □ **MM Electronics**, French's Mill, French's Rd., Cambridge, England CB4 3NP □ **Moog/Norlin**, 7373 North Cicero Ave., Lincolnwood, Ill. 60466, Customer Service: 2500 Walden Ave., Buffalo, N.Y. 14225 □ **Musicomputer**, P.O. Box 1070, Canyon Country, CA 91351 □ **Music Technology/Crumar**, 105 Fifth Ave., Garden City Park, N.Y. 11040 □ **Musitronics Corporation**, Sound Lab 10, Rosemont, N.J. 08556 □ **New England Digital Corp.**, P.O. Box 305, Norwich, Vermont 05055 □ **Oberheim Electronics**, 1549 Ninth St., Santa Monica, Calif. 90401 □ **Octave Electronics Inc.**, 35-73 Steinway St., Long Island City, N.Y. 11103 □ **PAIA\***, Box 14359, Oklahoma City, Okla. 73114 □ **Pollard Industries, Inc.**, 9014 Lindblade St., Culver City, Cal. 90230 □ **Polyfusion Inc.**, 160 Sugg Road, Buffalo, N.Y. 14225 □ **Rocky Mount Instruments, Inc.**, Macungie, Penn. 18062 □ **Rolandcorp U.S.**, 2401 Saybrook, L.A., Cal. 90040 □ **Saputelli Music Systems**, P.O. Box 40267, San Francisco, Cal. 94140 □ **Scalatron/Motorola**, 2130 N. Palmer Dr., Schaumburn, Ill. 60196 □ **Sequential Circuits**, 1172-G Aster Ave., Sunnyvale, Cal. 94086 □ **Serge Modular Music**, 1107-1/2 N. Western Ave., Hollywood, Calif. 90029 □ **Software Technology Corp.**, P.O. Box 5260, San Mateo, Cal. 94402 □ **Solid State Music**, 2102A Walsh Ave., Santa Clara, Cal. 95050\*\* □ **Star Instruments Inc.**, Box 71, Stafford Springs, Conn. 06076 □ **Steiner-Parker**, 2258 South, 2700 West, Salt Lake City, Utah 84119 □ **Stramp**, 3-2000 Hamburg 53, Bornheim 19, Germany □ **Strider Systems**, P.O. Box 2934, Norman, Okla. 73070 □ **Syn-Cordian**, 32:73 Steinway St., Long Island City, N.Y. 11103 □ **THINC-Technical Hardware Inc.**, P.O. Box 3609, Fullerton, Calif. 92634 □ **VAKO, Synthesizers Inc.**, 4651 62nd Avenue North, Saint Petersburg, Florida 33565 □ **Wavemakers**, P.O. Box 27, Edmonds, Wash. 98020 □ **Yamaha International**, Box 6600, Buena Park, Calif. 90620 □ **360 Systems**, (213) 384-8447, 2825 Hyans Street, Los Angeles, Calif. 90026

Note: \* manufacturer makes kits only  
\*\* manufacturer makes both kits and finished product

## Consultants

**Analog Systems**, P.O. Box 1559, Boulder, Colo 80306 (303) 499-4236 □ **Audio Designs**, 3422 Brookfield Ln., Decatur, Georgia 30032 (404) 284-8651 □ **Michael J. Boddicker**, (213)

985-0010 □ **Boston Experimental Electronic Music Projects**, Robert Ceely, 33 Elm St., Brookline, Mass. 02147, (617) 731-3785 □ **Cincinnati Independent Electronic Studio**, David McClanahan, 2703 Coy St., Cincinnati, OH 45219 (513) 421-9025 □ **Clark Ferguson**, 83 Cherry Lane, Macungie, PA 18062 □ **Clean Music Systems**, 131 S.E. Fifth St., Hallandale, Fla. 33009, (305) 454-4601 □ **Danbury Electronic Music Center**, 84 Federal Rd., Danbury, Conn. 06810 (203) 792-2794 □ **Different Fur Music**, John Vieira, 3470 19th St., San Francisco, Calif. 94110, (415) 863-WAVE □ **Disco Tech Musical Electronics**, Prospect Mall, 2239 North Prospect, Milwaukee, Wisconsin 53202 (414) 271-9291 □ **Dorje Sound**, Chet Wood, P.O. Box 2232, Berkeley, Calif. 94702 □ **DS Music**, 811 Franklin St., Santa Monica, Calif. 90403, (213) 463-8772 □ **Electronic Music Consulting**, Michael W. Gilbert, 104 Riverglade, Amherst, Ma. 01002 (413) 253-2786 □ **Electronic Music Studio**, Dwight D. Gatwood, Director, University of Tenn., Martin, Tenn. 38238 (901) 584-7402, 578-2281 □ **Electronic Music Users Studio**, 37 Sussex St., San Francisco, CA 94131 □ **The Elektrik Keyboard, Ltd.**, 1920 North Lincoln Avenue, Chicago, IL 60614 (312) 751-1555 □ **EMSA (Electronic Music Studios of America, Inc.)**, 269 Locust St., Northampton, Mass. 01060 (413) 586-3777 □ **Entropy West Electronics**, Eric Valinsky, 1242 Harvard St., Santa Monica, Calif. 90404 (213) 828-0389 □ **Exploratory Electronic Music**, Steven C. Bilow, 16685 Calneva Drive, Encino, California 91436 (213) 789-8885 □ **Keyboard Services**, P.O. Box 975, Baton Rouge, La. 70821 (504) 924-3858 □ **Laine Research & Development**, P.O. Box 3219, Fullerton, Cal. 92634 (714) 871-1923 □ **Lectron Music Lab**, Box 1594, Hollywood, Calif. 90028 □ **Stan Levine**, 13508 Debell St., Pacoima, Calif. 91331 (213) 899-7223 □ **Musicians Service Center**, 11321 Santa Monica Bl., West Los Angeles, CA 90025 (213) 473-6726 □ **Paradox EMS, Inc.**, 116 West Broadway, Vancouver, B.C., Canada V5Y 1P3 □ **Patchwork Sound**, Jack Howe, 14759 Hesby St., Sherman Oaks, Calif. 91403 □ **People's Computer Company**, P.O. Box 310, Menlo Park, Calif. 94025 □ **Pi Corporation**, 1741 East 24th St., Cleveland, Ohio 44114 (216) 781-2207 □ **Ron Rivera**, 48 Brighton Avenue, No. 11, Allston, Mass. 02134 □ **Ed Schaefer Enterprises**, P.O. Box 26521, 1049 S. Garland Way, Denver, Colorado 80226 (303) 988-9090 □ **John Snyder, Experimental Music Studio**, 315 Kear St., Yorktown Heights, N.Y. 10598 (914) 962-5299 □ **Sound Arts**, 2825 Hyans St., Los Angeles, Calif. 90026 (213) 487-5148 □ **Dr. Phillip Springer**, Box 1174, Pacific Palisades, Calif. 90272 (213) 454-5275 □ **Star Track Recording Studio**, 8615 Santa Monica Blvd., Los Angeles, Calif. 90069, (213) 855-1171 □ **Carter Thomas**, Mangel Road, Spring Glen, N.Y. 12483 (914) 647-9121 □ **TNY Music & Engineering**, Route 4, Defreestville, N.Y. 12144 (518) 283-2837, 283-2899

## Schools

**BEEP Electronic Music Workshops**, 33 Elm Street, Brookline, Ma. 02146 (617) 721-3785 □ **Boston School of Electronic Music**, 127 Kilsyth Rd., Brighton, Mass. 02135 (617) 734-4500/4501 □ **Con Tempo Music Guild**, 13273 Ventura Blvd., Studio City, California 91604 (213) 784-8271 □ **James D. Craig Music**, 511 Cedar St., Allentown, Penn. 18102 (215) 437-4743 □ **Dick Grove Music Workshops**, 12754 Ventura Blvd., Ste. 2, Studio City, Calif. 91604 □ **Hawaii Electronic Music Group**, Box H-8 Room 213, 2445 Campus Rd., Honolulu, HA 96822 (808) 955-2839 □ **Omega Intermedia Center**, 3433 North Halsted, Chicago, Ill. 60657 (312) 477-9863 □ **PASS Public Access Synthesizer Studio**, 135 W. Broadway, New York, N.Y. 10013 □ **Sherwood Oaks Experimental College**, 6353 Hollywood Blvd., Hollywood, Calif. 90028 (213) 462-0669

## Sound Products & Accessories

**Alembic**, P.O. Box 759, Sebastopol, Calif. 95472 (707) 823-8579 □ **Analog/Digital Associates**, 2316 Fourth St., Berkeley, Cal. 94710 □ **Asgard Inc.**, 22 Huron St., Providence, RI 02908 □ **Audio Pulse**, 4323 Arden Dr., El Monte, Cal. 91731 □ **Audio Rents**, 6856 Sunset Bl., Hollywood, CA 90028 (213)

461-3351 □ **Barcus-Berry**, 15461 Springdale St., Huntington Beach, Cal. 92649 □ **California Optoelectronic Industries**, 999 Commercial St., Palo Alto, CA 94303 □ **Carvin Music and Sound**, 1155 Industrial Ave., Escondido, Calif. 92025 □ **E Bow/Heet Sound Products**, 611 Ducommun St., Los Angeles, Calif. 90012 (213) 687-9946 □ **Electro-Harmonix**, 27 West 23rd St., N.Y., N.Y. 10010 □ **Electro-Voice**, 674 Cecil St., Buchanan, Mich. 49107 □ **Eventide Clockworks, Inc.**, 265 West 54th St., New York, N.Y. 10019 (212) 581-9290 □ **FRAP**, Box 40097, San Francisco, Calif. 94140 (415) 824-2223 □ **FROGG (Design Engineering Labs Inc.)**, 4121 Redwood Ave., Los Angeles, Calif. 90066 (213) 823-8220 □ **Hammond**, 4200 Diversey, Chicago, Ill. 60639 □ **Heil Sound Systems**, Heil Industrial Blvd., Marissa, Ill. 62257 □ **Ibanez/Elger Co.**, P.O. Box 469, Cornwelles Heights, PA 19020 □ **Infitheatre Inc.**, 4990 Mass Ave., Indianapolis, Ind. 46218 □ **J. D. Electronics, Inc.**, P.O. Box 2205, Berkeley, Cal. 94702 □ **Keas Electronics, Inc.**, 210 W. Main, Chanute, KS 66720 □ **Marshall Electronic**, Box 177, Joppa, MD. 21085 □ **Mellotron/Sound Sales Inc.**, Sherman Conn. 06784 □ **Micmix Audio Products, Inc.**, 2995 Ladybird, Dallas, TX 75220 □ **Morley Electronics**, 2301 West Victory Blvd., Burbank, Calif. 91506 (213) 843-7122 □ **Musico**, 1225 N. Meridian St., Indianapolis, Ind. 46204 □ **MXR Innovations**, P.O. Box 722, Rochester, N.Y. 14603 □ **Pro Sound**, 13717 S. Normandie, Gardena, Cal. 90249 □ **Rocronics Entertainment Lighting**, 22 Wendell St., Cambridge, MA 02138 (617) 354-4444 □ **Ross Musical Products/Keas Electronics Inc.**, 210 W. Main, Chanute, KS 66720 (316) 431-0400 □ **Rothchild Musical Instruments** (distributor Furman and Alembic products), 65 McCoppin St., San Francisco, Calif. 94103 (415) 626-2260 □ **The Ken Schaffer Group**, 10 East 49th St., New York, New York 10017 □ **Sennheiser Electronic Corp.**, 10 West 37 St., New York, N.Y. 10018 □ **TAPCO**, 3810 148th Ave., NE, Redmond, WA 98052 (206) 883-3510 □ **Wasatch Music Systems**, P.O. Box 9175, Salt Lake City, Utah 84109

## Sound Recording

**Ampex**, 401 Broadway, Redwood City, Calif. 94063 (415) 367-4544 □ **dbx Incorporated**, 296 Newton St., Waltham, Mass. 02154 (617) 899-8090 □ **Dokorder**, 5430 Rosecrans Ave., Lawndale, Calif. 90260 □ **Dolby Laboratories Inc.**, 731 Sansome St., San Francisco, Calif. 94111 (415) 392-0300 □ **EDCOR**, 3030 Red Hill Ave., Costa Mesa, Calif. 92626 (714) 556-2740 □ **Furman Sound**, 616 Canal Street, Suite 25, San Rafael, California 94901 (415) 456-6766 □ **Magnetic Reference Laboratory, Inc.**, 229 Polaris Avenue, Suite 4, Mountain View, Calif. 94043 (415) 965-8187 □ **Maxell Corporation of America**, 130 West Commercial Ave., Moonachie, New Jersey 07074 □ **Nagra Magnetic Recorders, Inc.**, 19 West 44th St., Room 715, New York, N.Y. 10036 □ **Orban/Parasound**, 680 Beach St., San Francisco, Calif. 94109 (415) 673-4544 □ **Otari Corporation**, 981 Industrial Road, San Carlos, California 94070 (415) 593-1648 □ **Philips Audio Video Systems Corp.**, 91 McKee Drive, Mahwah, N.J. 07430 □ **Scientific Audio Electronics Inc.**, P.O. Box 60271, Terminal Annex, Los Angeles, Calif. 90060 □ **Scotch/3M Magnetic Audio/Video Products Division**, 3M Center, Saint Paul, Minn. 55101 □ **Scully Recording Instruments**, 475 Ellis St., Mountain View, Calif. 94943 □ **Shure Brothers Inc.**, 222 Hartrey Avenue, Evanston, Ill. 60204 □ **TDK Electronics Corporation**, 755 Eastgate Blvd., Garden City, N.Y. 11530 □ **TEAC Corporation of America**, 7733 Telegraph Road, Montebello, Calif. 90640 □ **Telex Communications Inc.**, 9600 Aldrich Avenue South, Minneapolis, Minn. 55420 □ **United Recording Electronics Industries**, 8460 San Fernando Rd., Sun Valley, CA 91352 (213) 767-1000

## Classified

**Classifieds:** Synapse provides classified ad space at a minimum rate as a service to our readers. Ads are accepted from private parties only. 20 words or less \$2.00, 40 words or less \$5.00, 60 words or less \$15.00. Send payment with ad to: Synapse Classifieds, 2829 Hyans St., L.A., CA 90026.

Synthesist/composer would like to communicate with others interested in electronic music. I have done some studio work, but need help and equipment to do more. Or just talk about electronic music. Also want to meet other synthesists who just want to improvise for awhile. **Chuck Larriou**, Box 294, Corte Madera, CA 94925 (415) 457-8791.

**Aries Modular Synthi**, 18 modules, 5 octave keyboard, V.C. flanger, multimode filter, reverb, \$1300. **EML Polybox**, \$325. 206-283-6730.

For Sale: 2 1/2 panels of Serge modules with box, power supply and patch cords. **Ron Hillman** (213) 654-5399

I must part with my Oberheim expander module, good as new, for \$425.00. Also ARP model 1027 analogue sequencer and ARP model 1050 sequential mixer modules for \$495.00, or \$275.00 each. Call **Don**, (808) 732-7946 before 7:00 a.m. Hawaii time.

**Steiner-Parker Synthacon and Electronic Valve Instrument**. Retailing for \$650.00 and \$450.00 respectively. Selling to best offer. (319) 351-0055.

**Dormouse** makes the absolute best custom made leathers for musicians—guitar straps, bags, cases, other services available. PO 1934, Cincinnati, OH 45201

**Cat SRM** [From page 45] is determined by the slider. The advantage is obvious. The rate of S&H, FM of the VCO's, or VCF is now a known factor to the performer and this saves both time and inconvenience for player and listener alike.

In addition to all this, the Cat SRM is set up in a way that minimizes confusion, with all related functions located near each other, making for quick and easy setting changes; and the control panel is arranged for maximum efficiency under less than optimal lighting conditions.

The Cat also has other more standard features, such as glide, S&H, and noise. As a performance synthesizer with some interesting possibilities, this one is a good investment.

—Melodie Bryant

# WHAT'S HAPPENING

[From page 8]

... **Moog** (distributed by **Norlin**) has marketed the **SynAmp**, an amplification system made especially for synthesizer. Featured are parametric EQ, compression, graphic EQ, effects send, 4 input channels (2 inputs each), headphone monitor amp., house sound kill switch, and clipping indicators. Four hundred watts continuous average power output can be fed to two 15" low frequency drivers, a compression driver and horn for the mid-range, and tweeters for the high range. The user may select from two power amp to speaker hook-ups. For more information, write: Norlin, 7373 North Cicero Ave., Lincolnwood, Ill. 60646.....

... **Roland Corp** US, 2401 Saybrook, LA, CA 90040, has released several new synthesizers recently. The **SH-7** is a duophonic keyboard instrument with dual sample and hold, so that both notes will hold pitch after the keys have been released. The \$1,895 unit features a 24 db VCF with external signal envelope follower, and a "bender" that can control the VCO, VCF, and

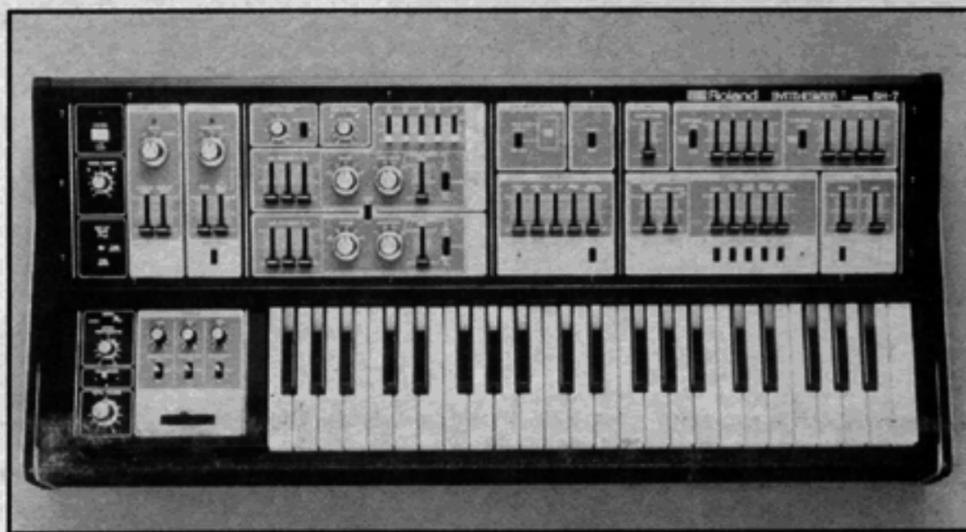

## Roland's SH-7 has a duophonic keyboard.

VCA. The **RS-505** "is a paraphonic ensemble, a strings and synthesizer combination," with a tag of \$1,895. The **PO-44 Space Bird** is a "four-voice polyphonic synthesizer with computer memory," listing for \$2,695. No further information has been furnished on these instruments yet. Roland has also announced plans to introduce additional guitar synthesizer models later on this year.....

... The **Model 440 Automated Panning System** has been released by **Asgard, Inc.**, 22 Huron St., Providence, RI

02908. The system provides simultaneous quad panning and quad envelope generation. The system consists of a cathode ray tube for visual monitoring of location co-ordinates, power supply, an LFO module with division circuits and a pan lock switch, and two modules responsible for the "X" and "Y" location co-ordinates. The 444-x, and 444-y modules control the waveform, phase, division and inversion of the LFO module. The system lists for \$1,920.00.....

... **MICMIX Audio Products, Inc.**, 2995 Ladybird Lane, Dal-

las, TX 75220 has released the **Dynaflanger** (list, \$895.00). The system allows control of the flanger by the program material, using either the frequency or amplitude information. It will also react to external inputs such as a synthesizer. Of special interest to synthesists, are dynamic control voltage outputs generated by the dynamic operating modes. The frequency response of the direct signal is 20 Hz to 20 KHz, and the delayed signal is 25 Hz to 13 KHz.....

... **California Optoelectronic Industries**, 999 Commercial St., Palo Alto, CA 94303 have introduced the **KB 2200** dual-sided mobile remote electronic keyboard. The KB 2200 can, according to manufacturer's literature, control any number of keyboard instruments with its split 6 and 3/4 octave keyboard. The 15 pound keyboard lists for \$1500.00.....

... For the owners of the Fender Rhodes Suitcase Piano, **MR Engineering Company**, 4730 W Addison, Chicago, IL 60641, has released a **power supply** to do away with the speaker section. List price is \$100.00.....



## Screamers

[From page 23]

**What are you building out here?**

**Tomata:** Sawdust.

**Gear:** A temple to punk rock... I think we're in a period of transition in a sense; barriers are being blurred or being redefined—it puts everything in a jumble. I think that's why punk music came along when it did, is because of the redefinition of categories.

**Tomata:** First they called us punk, then they called us art, now they call us techno-punk...

**K.K.:** Yeah, we've been going down a list to see what we can

indoctrinate everybody else to think is "new."

**Gear:** We also had the reputation of being a mental health or psychotherapy band. At least we're getting away from that, although we played at Camarillo State Mental Hospital recently.

**Tomata:** There was this girl there who kept following me from one side of the stage to the other just rubbing her tits and going "punk rock... punk rock."

**Gear:** The best part was a guy who sat at the edge of the stage and for the entire duration of the show prayed to Tomata... I don't know if I believe in God, but definitely the power of prayer.

**Would the Screamers use sound patterns proven invariably to produce certain responses in listeners?**

**Gear:** It could be used, but there would have to be a warning, like on drugs, "This could be hazardous"...

**Tomata:** It would be interesting if we could stimulate cardiac arrest... to see them drop...

**On alternate modes of**

**communication:**

**Tomata:** It's kind of interesting when you see people on the street who are flipped out or retarded, in the way they talk or try to express themselves, but they really can't, so it's like animal sounds, things like that, they jerk about, their hands go... I'm really fascinated because they are saying something and it's very... lucid, the way their sounds are made, and it's sometimes more direct than if they were speaking common English.

**Gear:** It's developing a language that goes beyond differences... sounds that come from inside their organism rather than from their brain.

**On music:**

**Gear:** Popular music has suffered what I refer to as a tyranny of guitars. It would be like in classical music if they were to feature one instrument alone... The synthesizer as you know is a very versatile instrument, but every time I see it, it's used just as a mere sound effect device.

**Tomata:** It's a whoopee cushion.

**General statements:**

**Gear:** "I took some cockroach eggs and autoclaved them at 500 degrees to see what would happen and they still hatched live."

"Style... You can't really separate the information from the means of communication."

"We have these French exchange students across the street and they do these exercises on the front lawn."

"We want to escalate the impending stagnation of pop music."

"The way people are today, I'm more concerned with inciting them to do anything—any kind of awakening would be welcome."

**Tomata:**

"We were in a restaurant the other night that used to be a mortuary."

"The Comte St. Germain (influential legendary world figure supposed to have lived hundreds of years)... Now there's a religion in Pasadena that worships him."

"Halloween's coming up."

"We're obsessed."

—Greg Burk

# The Oberheim Four Voice Polyphonic Synthesizer with Programmer is So Advanced, It's Simple.

Some have said "Oberheim is too complex for performance use." We admit that it looks that way...

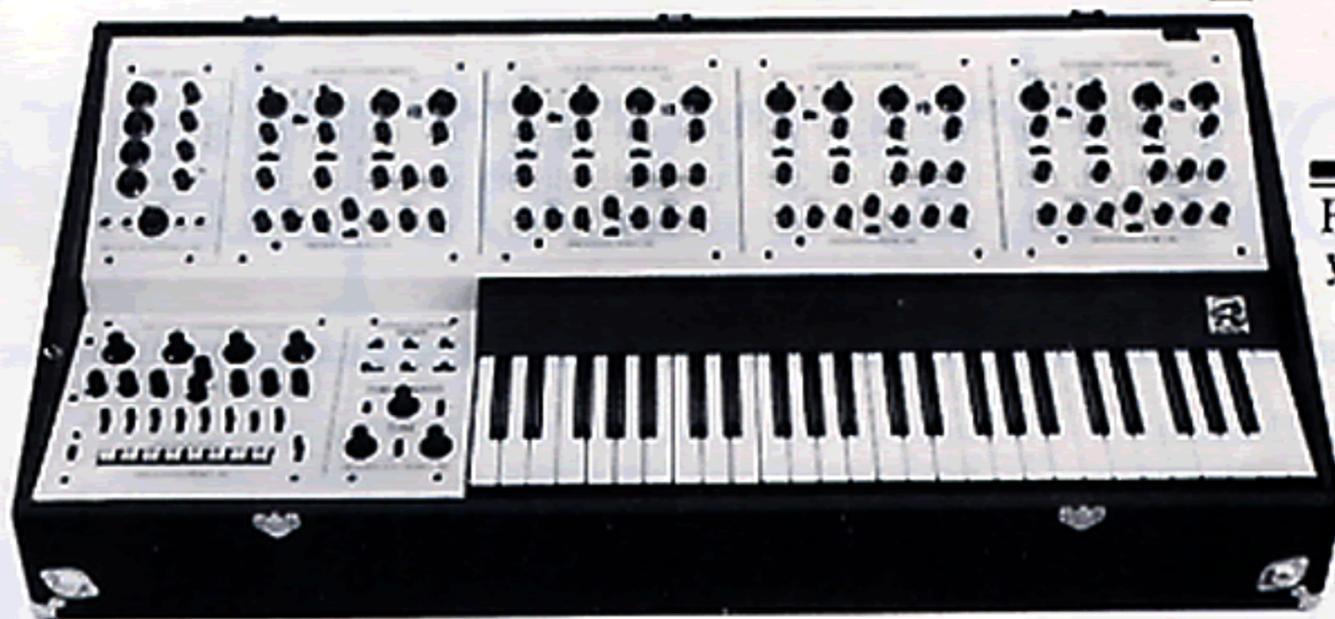

Further, once you've exhausted all the possible sounds achievable with the expander module set as recommended, you can try a host of other

However, once you set up the expander modules as shown and have tuned the oscillators... your four voice is no more complex than shown below, because you now control the expander modules from the programmer module in the lower left hand corner of the machine. Actually you have fewer controls to fool with than most other single voiced variable synthesizers. Yet you have four complete synthesizers plus the capability of storing 16 polyphonic programs or 64 monophonic patches.

sounds by varying those parameters of the expander module that are shaded.

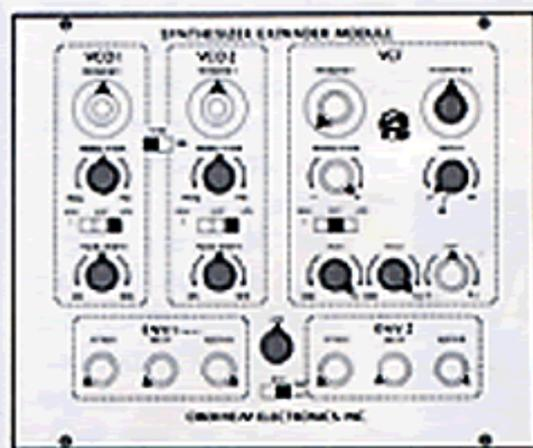
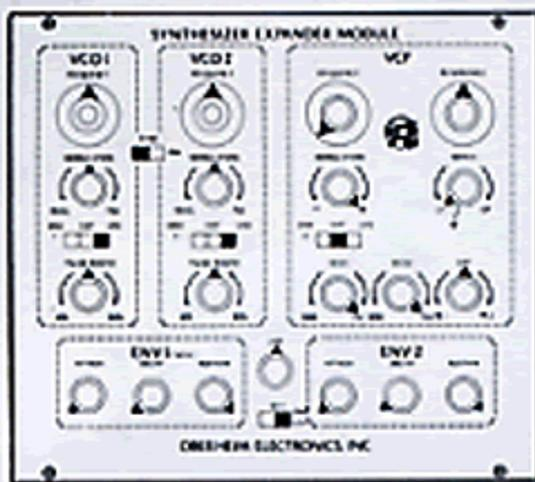

The possibilities are limitless, yet only as complex as your imagination. To find out just how limitless, write to us here at Oberheim, Department 57.



**Oberheim**  
Some Things Are Better Than Others

Oberheim Electronics, Inc., Dept. 57  
1455 19th St., Santa Monica, Ca 90401

# The most played synthesizers in the world are now the most playable.

The distinctive Arp sound has made the Axxe and the Odyssey the most popular synthesizers in the world. Now we've made them even better.



We've improved the Human Engineering of the Axxe and the Odyssey, re-designing their control panels so that musicians will find them easier and more expressive to play. The color-coded block diagrams and sliders give you a quick, clear reading of what sounds you have set up, and how you're changing them.

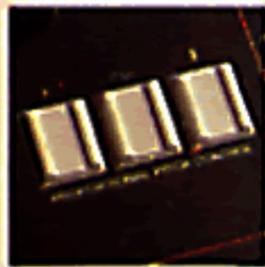

Arp Human Engineering is also behind the addition of PPC, the Proportional Pitch Control that lets you shape your music as you feel.

The harder you dig your fingers in, the more PPC bends the pitch and adds vibrato.

The Axxe and Odyssey are built to help your performance both on stage and in the studio. Their extended keyboards make them easier to play even when stacked with other keyboards, and both can be expanded



by adding on other Arps with our systems interface jacks.

Arp is the only line of synthesizers that's meticulously designed and built to produce clean, true sound. They're musical instruments, built strong to withstand the rigors of travelling. They've been proven by their years of successful use by top artists all over the world.

The Human Engineering isn't the only thing that's been improved about them. We've also re-designed their prices, making it easier than ever for you to play an Arp. Check out the Axxe and Odyssey at your nearest Certified Arp Dealer.



 ARP

45 Hartwell Avenue, Lexington, Mass. 02173.