

THE ELECTRONIC MUSIC MAGAZINE

# Synapse

Malcolm Cecil  
and TONTO



SYNAPSE/STAR INSTRUMENTS SYNTHESIZER  
GIVEAWAY • ELECTRONIC GUERRILLAS INVADE  
BAY AREA

Synapse and Star Instruments Inc.  
 join in wishing you a happy holiday  
 with the giveaway of the  
**SYNARE Percussion Synthesizer**  
**(Value \$695)**



*The SYNARE Percussion Synthesizer, the first of a family of revolutionary electronic music instruments from STAR Instruments, is the world's first fully integrated percussion synthesizer.*

*SYNARE P.S.\* has been designed to be used with or without a drum set and is activated by striking its all natural rubber Percussion Pads. No alteration of "sticking" technique is required and the Pads, like a tympani head or roto-tom, may be tuned to any desired pitch/timbre range. Further modification of the "synthesized sound" may be accomplished by "where" on the Pad your stick (or hand) lands, in other words the Percussion Pads are "zone" sensitive. This gives the drummer/percussionist a tremendous degree of expressive control.*

*Four main sources, full mixing, dual voltage controlled amplifiers, and a wide range voltage controlled filter offer unlimited sound generation possibilities for the progressive drummer/percussionist. And SYNARE P.S.\* is as adaptable as it is versatile. It can be positioned in a number of ways so it will be compatible with the arrangement of your drum set and comfortable to reach as you play.*

*The world of electronic percussion is ready for you now, and STAR Instruments has made it affordable. Included in the giveaway is the standard SYNARE accessory package which includes:*

**ACCESSORY PACKAGE**

*a SYNARE P.S. Guide Book and "PATCH SCRATCH" Pad, a Mounting Plate and hardware package for attaching SYNARE to the LUDWIG Stand Model # 1345-2, a 6' phone-to-phone patchcord, a 6' phone-to-RCA patchcord, four Replacement slider caps and a Registration Card.*

**TO WIN:**

1. Fill out the Synapse Giveaway blank and mail it to: Synapse Giveaway, P.O. Box 359, N. Hollywood, California 91603. One entry per postmarked envelope.
2. All entries must be postmarked no later than January 31, 1977. Drawing will be held February 3, 1977. The winner will be notified by mail.
3. Employees of Synapse and Star Instruments, Inc., are not eligible. **Turn to page 8 for the Synapse/Star Giveaway entry blank.**

# Synapse

NOVEMBER—DECEMBER VOLUME 1 NUMBER 4

**Editors**

Angela Schill, Douglas Lynner

**Design and Production**

Chris August

**Photography**

Bill Matthias

**Correspondents**

Northern California: Phil Loarie

Connecticut: Chuck Scribner

Maryland: Paul Medlock

New York: Randy Cohen

**Contributors**

Craig Anderton, Arpad Benares,

Alex Cima, Jon Christie, Tom Davey

Bob Davis, Sue Denim, Luther Donaldson,

Peter Hillen, Stan Levine,

Virginia Quesada, Bryce Robbley,

Danny Sofer, Phil Terr,

Richard Wadholm

SYNAPSE MAGAZINE is published bi-monthly by Schill and Lynner, P.O. Box 359, N. Hollywood, Cal. 91603. (213) 986-3951, 361-6625. No part of this magazine may be reproduced, either mechanically or by other means, without the written permission of the publisher. Copyright 1976 by Douglas Lynner and Angela Schill Publishing. Printed in the United States of America.

SUBSCRIPTIONS: U.S. and Canada \$6.00 for six issues, foreign subscriptions \$7.50 for six issues. Single copy newsstand price is \$1.25.

MANUSCRIPTS: We cannot be responsible for the return of any unsolicited manuscripts, photographs, artwork or scores. All contributions are welcome and should be addressed to: SYNAPSE MAGAZINE, P.O. Box 359, North Hollywood, California 91603.

CHANGE OF ADDRESS: Notify SYNAPSE MAGAZINE/SUBSCRIPTION DEPARTMENT, P.O. Box 359, North Hollywood, California 91603. Please send both the old and new addresses, and if possible, the mailing label from a copy of SYNAPSE.

## Electronic Guerillas Invade Bay Area 9

Citizens Asked to Remain Calm

Bob Davis

## Interview with Bob Easton of 360 Systems . . . . . 12

"I wanna hook one up to a steel guitar and . . ." Angela Schill

## Malcolm Cecil and TONTO . . . . . 17

"bump, bump, bump, what is all that noise?" Doug Lynner and Bryce Robbley

## Sound Arts . . . . . 22

More than a Recording Studio Luther Donaldson

## A Big Synthesizer's Little Helpers. . . . . 26

Manual Controllers, Presets and Presto Patches Arpad Benares

## Illusion and Motion. . . . . 24

Two Simple Dichotic Patches Alex Cima

Editors' Note . . . . .	2
What's Happening . . . . .	2
Letters . . . . .	3
Composer/Performer . . . . .	6
Computers . . . . .	4
Sample and Hold . . . . .	5
Equipment Review . . . . .	28
Disc Review . . . . .	30
Book Review . . . . .	36
Classified Ads . . . . .	36

## EDITORS' NOTE

With this issue we bring you three new features: the Composer/Performer column, Equipment reviews, and a Synthesizer Giveaway. Composer/Performer will regularly feature musicians ranging from unknown to well known, who fulfill the double role of composing and performing their own works. We introduce this column with composer/performer Carter Thomas, whose work is centered on timbral modification of acoustic instruments.

In this issue's Equipment Reviews, we evaluate three of the major contenders for the Polyphonic spotlight: the "Polymoog," the Oberheim "four Voice," and the Arp "Omni." We also present for the first time, the SYNAPSE Synthesizer Giveaway.

In cooperation with Star Instruments, Inc., we are offering you the all new "Synare Percussion Synthesizer." Enter now and be the first on your block . . . Not stopping at that, we bring you Malcolm Cecil, Bob Easton, and three Electronic Guerillas.

# WHATWHATWHATWHAT WHATWH **WHAT'S** WHATW WHATW **HAPPENING** ATW

**Oberheim Electronics** will soon be releasing an A/D, D/A converter so that patches can be stored on audio cassettes and called up when needed, adding greater flexibility to their **Polyphonic Synthesizer Programmer** . . . **San Wyman** of **Sound Arts** has finished writing the **Moog Modular Synthesizer Manual** which should be available soon . . . A new guitar synthesizer is forthcoming from **D.B.L. Electronics**. Some features will include additive synthesis of up to 32 audible harmonics for each string, computer control of all synthesizer subsystems, no patch cords or knobs, and instant recall of programs . . . **Pieces**, an anthology of new music scores and writings by North American composers is now available from **Michel Byron**, P.O. Box 143, Maple, Ontario, LOJ 1EO, Canada, for \$5.50, includes postage. **Pieces** features works by **Marion Brown, Harold Budd, Daniel Lentz, David Behrman, Robert Ashley** and **James Tenney** . . . **Bob Easton** of **360 Systems** now has available a "poor peoples" guitar synthesizer for \$750.00, the "Slavedriver" guitar synthesizer will follow any single line or top note of any chord . . . **Laser Images, Inc.** premiered **Laserium II** at the Griffith Park Observatory in Los Angeles on October 28. **Laserium II** combines laser projections and music (mostly electronic) to create exciting visual and aural performances throughout the U.S., Canada and Japan . . . **Star Instruments, Inc.** has released their "Synare P.S." (**Percussion Synthesizer**). See the Synapse/Star "Giveaway" page in this issue for more information . . . **National Semiconductor Corporation** has published the **Audio Handbook**. It includes schematics information and good advice on such things as amplifiers, mixers, octave equalizers, limiters, reverb, phase shifters and voltage controlled amplifiers. For information write: **National Semiconductor Corporation**, 2900 Semiconductor Drive, Santa Clara, CA 95051 . . . **The Delta-Graph Electronics Company**, P.O. Box 741, Pasco, Washington 99301, has released the model EQ-10 graphic equalization system, a 10-channel, modular equalizer kit for \$56.00 per channel module . . . Computers and electronic music will be the subject of the February 19th symposium presented by the **Southern California Computer Society in Los Angeles**. There is still room for contributions to the program. For more information, call George Atwood at (213) 377-7703 . . . **The Electronic Quintet (EMQ)** will soon begin their second California concert series, look for them . . . **Sanrio Films**, has contracted **Sound Arts, L.A. Cal.**, to provide electronic music for the prologue of a full-length Fantasia-style, animation based on Ovid's *Metamorphosis* . . . Los Angeles is now host to a new EM school, the "**Los Angeles Center for Electronic Music**." LACEM is staffed by **Alex Cima** and **Bryce Robbley**, both members of LEM and experts in the field of voltage control. Classes start Jan. 8, 1977. Call (213) 463-8772 for information . . . Note: Please refer to Listings for any addresses not given above.

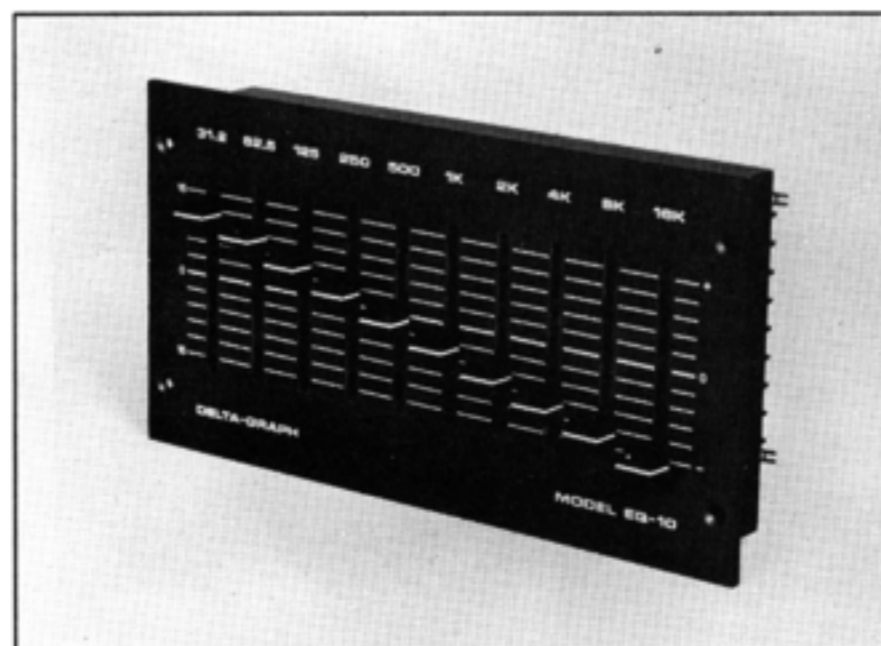

The EQ-10 modular equalizer from Delta-Graph Electronics.

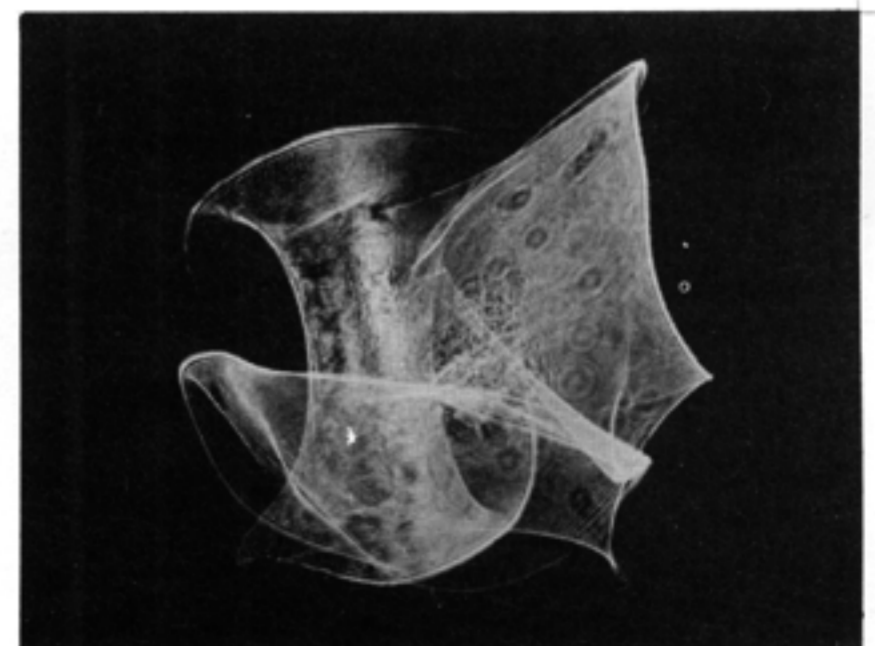

Laser Images, Inc. recently premiered Laserium II in Los Angeles.

# LETTERS

*Just came across the Sept.-Oct. Synapse and was very pleased to read the review of my concert last July. Also, am very impressed with the new Synapse layout.*

Jasun Martz  
La Crescenta, Calif.

*The issue of Synapse that I received today delighted and impressed me by its approach to both musical and technological matters.*

*My congratulations on what appears to be an excellent and a much-needed magazine.*

*Yours sincerely,*

Jerry Hunt  
Dallas, Texas

*Needless to say, I am interested in what you are doing. Glancing through your magazine, I can see a lot of interesting editorial material, especially your report of innovative work by artists.*

*My own interest is in the area of cutting through jargon and the mystique smokescreen to show how basic and simple a lot of electronic music concepts are. I believe this is your interest as well. I certainly don't believe that musicians have to be engineers, but I do believe that any active musician or serious music listener must understand signal flow, basic electronic processing of audio signals (such as amplification, mixing, filtering, etc.), and feel at home with a patch cord and voltmeter. I am certainly not against acoustic instruments or traditional music. It's just that so much of our contemporary musical experience comes to us through electronics and it is actually unrealistic to regard electronics as merely reproducing a live performance.*

*Sincerely,*

Robert A. Moog

*Thank you for the first "new" issue of Synapse. I am glad to see that someone has carried on Brett Webster's original idea.*

*I hope I will be contacted for future issues. If the ARP 2600 is to be falsely represented in interviews with Tom Oberheim, the least I can do is to refute his unfortunate and inaccurate comments (ARP does have a polyphonic synthesizer!).*

*Thank you for reviving Synapse.*

*Sincerely,*

Bob Hoffman  
Advertising Manager  
ARP Instruments, Inc.

*I have been looking for a magazine that can relate to the needs of a synthesizer composer-performer and yours seems to take the right tack between commercial blurb and electronic mysticism, somehow avoiding either extreme, just practical (and provoking) ideas and (hopefully) patches. Don't lose your course!*

Paul Henry  
Passaic, N.J.

*Greetings! I didn't know that you had started a magazine about electronic music. Synapse is of course very professionally done. I look forward to seeing issues, particularly as you get established enough to include deeper articles (apart from schematics) once you have the magazine out there for a while. So far, though, there is an interesting tone to the articles, and the more one thinks about it, the more Southern California seems an appropriate place to base an incursion into the dominant culture. Electro-acoustic music (electronic, computer, concrete, live) is indeed happening; people are focussing onto something.*

*I notice that you solicit information on electronic composers for your files. I enclose some information.*

*That's it, best of luck and continued circulation.*

Curt Roads  
Del Mar, Calif.

*I just got your 3rd issue yesterday and I can't put it down. I love it. My favorites are the Oberheim Interview, Computers with Peter Hillen, Kraftwerk Interview, Audium, Taking It to The Streets, and the ASR thing with Benares. Oh, the Synergy thing was good too. Guess it would have been easier to list my least favorites, which is not too say I didn't like them either.*

*Your advertisers are new to me and have provided yet more people to contact for assistance.*

*I really like the breakdown of articles, Forum, Interviews, Engineering and Events, that you presently have.*

*I can't help but wishing you were monthly.*

*Thanks so much,*

Terry Ulvinen  
Vancouver, Washington

*I hope you can keep this thing going, I don't think there's another like it.*

*Wishing you much success,*

Hank Van Draanen  
Pasadena, Calif.

# COMPUTERS COMPUTERS COMP COMPUTERS **COMPUTERS** COMP COMPUTERS COMPUTERS COMP

## How Computers Store Numbers

with Peter Hillen

In the last issue I ended up promising that we would start an exploration of what computers and synthesizers could do together. Since then, I realized that we just barely scratched the surface of the interconnection problem. More time should be spent studying how computers and synthesizers do and do not go together before going on any further.

Since this magazine is about music and not computers, the biggest mystery is most likely the computer, so let's start with it.

Remember that a computer is a digital instrument; everything is represented as a discrete quantity. Those quantities are represented as numbers, not the 0 through 9 decimal numbers that we humans use, but rather *binary* numbers. Binary means two and that is how many digits there are in the binary system: 0 and 1. Computers like to use binary numbers because it is easy to represent the two digits electrically. For example, 0 = positive, 1 = negative or 0 = off, 1 = on. This is ideal because it is very easy to tell when voltage is off or on, positive or negative. Note that we are not concerned especially with the *value* of voltage, just whether it satisfies one condition or another. For the sake of discussion and also because it is the more universal convention, we will assign the digit 0 to the condition when voltage is not present, (or very small) and 1 to when voltage is present.

Great! Now we can count to 1. To count further, we must turn to binary arithmetic. Binary arithmetic is exactly the same as the decimal arithmetic, except that instead of

using the digits 0 through 9, we only use 0 and 1.

A brush-up on Base 10 "humans" arithmetic is in order at this point. Depending on the position of a digit in a number, it has a different value. For example, the number 365 means  $300 + 60 + 5$ . The 5 is in the units position ( $5 \times 1 = 5$ ); the 6 is in the 10's position ( $6 \times 10 = 60$ ); and the 3 is in the hundreds position ( $3 \times 100 = 300$ ). If there were more digits we would just extrapolate to 1,000's, 10,000's, etc. In more mathematical notation:  $365 = 3 \times 10^2 + 6 \times 10^1 + 5 \times 10^0$ . The same is true in binary arithmetic except that the place positions are separated by powers of 2 rather than powers of 10. So, instead of the places being 1, 10, 100, 1000, etc. they are 1, 2, 4, 8, 16, 32, 64, etc. Take the binary number 101. This really means  $1 \times 2^0 = 1$  (anything to the zero power is 1)  $0 \times 2^1 = 0$ ,  $1 \times 2^2 = 4$ . So, the number  $101 = 4 + 0 + 1 = 5$ .

A glance at the comparison chart will help you see the correspondence between decimal and binary arithmetic. If you wish to pursue the topic in more detail there are several beginning computer books available.<sup>1</sup>

A computer represents numbers as binary strings of 0's and 1's. Computer people refer to these strings as *words*. Inside the computer the words are held in an array of storage elements called a *register*. Each of the storage elements in a register have either a 0 or a 1 in it which is signified by the presence or absence of voltage on its output. The number stored in a register can be read by placing a voltmeter on each storage cell output and recording the voltage value converting the voltages to 0's or 1's and then calculating the number. This is exactly what a digital to analog converter does when it converts digital words to analog signals. In the next issue we will see how it does this.

<sup>1</sup> *Computers Made Really Simple*. Kent Porter, Thomas Y. Crowell Company. \$8.95.

Decimal = Binary

0	0
1	1
2	10
3	11
4	100
5	101
6	110
7	111

$$\begin{aligned} 101 &= 100 + 00 + 1 \\ &= 1 \times 4 + 0 \times 2 + 1 \times 1 \\ &= 1 \times 2^2 + 0 \times 2^1 + 1 \times 2^0 \end{aligned}$$

$$\begin{aligned} 365 &= 300 + 60 + 5 \\ &= 3 \times 100 + 6 \times 10 + 5 \times 1 \\ &= 3 \times 10^2 + 6 \times 10^1 + 5 \times 10^0 \end{aligned}$$

1	$10^0$	1	$2^0$
10	$10^1$	2	$2^1$
100	$10^2$	4	$2^2$
1000	$10^3$	8	$2^3$
10000	$10^4$	16	$2^4$
100000	$10^5$	32	$2^5$
Powers of 10		Powers of 2	

A Comparison of Decimal and Binary Arithmetic

# SAMPLESAMPLESAMPLESAMPLES SAMPLESAMPLESAMPLESAMPLES SAMPLESAMPLESAMPLES & HOLD

## A Sample of Serge Tcherepnin

with Stan Levine

The following is the result of a conversation between Serge Tcherepnin and myself.

I first met Serge Tcherepnin at Cal Arts in 1970, at which time he was a member of the composition faculty. My first experience with him was in a multi-media circuit design class.

Serge was interested in electronics and electronic music back in the 1960's. He was a composer and performer in both the United States and Europe. The thing that brought him into the design of electronic music equipment was his frustration at having to depend on other technicians to build and maintain his modules. Don't we all know this problem? This frustration grew, and Serge decided he needed to know more about electronics.

In 1965, relying on his Physics background and his feeling that electronics was simple, Serge began to acquire a better understanding of the hardware, and this was the beginning of *Serge Modular Music Systems*.

His approach from the beginning has been a personal one; Serge designs for an individual, not a mass market. Serge's are modular systems including, VCOs, VCAs, VCFs, and some modules of his own invention, such as, *positive and negative slews, the smooth and stepped generator, and the analog shift register.*

In 1973-74, the first Serge systems, also called "Serge-O-Phones", had been designed by Serge and were built by a group of students in a large room at Cal Arts. The evolution of Serge's electronic music instruments came about largely because of his interests as a composer, and also because of the influence of such people as: Charlemagne Palestine, Ingram Marshall, Randy Cohen, and Mort Subotnick, who were interested in innovative musical forms.

At this time, Serge developed some very unusual voltage controlled modules, such as *the negative slew*, which acts as a VCO, envelope generator, envelope follower, and a clock and pulse with modulator: a truly modular module.

One of the things that Serge especially like about his situation was that most of the systems were built by the people who were going to use them. These original systems were designed as kits so that semi-experienced people could put together their own low cost, yet versa-

tile synthesizer. Serge notes that all of these first systems are still making music and are being used by these same people. After all, that was the whole idea.

After this period, Serge left Cal Arts and began to freelance as a synthesizer manufacturer. It was at this time that he met Malcolm Cecil, a synthesizer programmer, composer, and performer in pop music, and began to design modules for Malcolm's TONTO. TONTO stands for: The Original New Timbral Orchestra, and can be heard on albums by Stevie Wonder, Billy Preston, and Joan Baez. This is when Serge learned the subtleties of building a synthesizer for pop music.

In the future, a concept that Serge is working toward is the complete home studio which would function for the composer much like the painting studio functions for the painter. Musically, this has not been possible because of both economic and emotional constraints. Economically, studios have been very expensive to own privately. Not only are the synthesizers expensive, but also the other production equipment such as multi-track recorders and mixing boards. Emotionally, trying to schedule time either in a university or commercial studio is very difficult. The freedom of working when, and how you want to is just not as possible as it is in your own studio.

Serge is trying to overcome these problems by first building synthesizers that are affordable and by working on computers and equipment that will some day replace the high priced equipment of today. For instance, one possibility is a computer that would replace the 24 track tape recorder; a computer that would give all the freedom and advantages of a tape recorder without the expense of the tape or the recorder itself. Thus Serge's ambition in the *personal studio*, built to an individual's specifications.

Presently, Serge is continuing development of innovative modules for the personal music studio. Serge is also working on what he considers to be more commercial equipment; by this he means, machines that would be more readily available in stores. In this area, he is working on real time musical instruments such as the *Rainmaker*, the *Electronic Guitar Pick*, and the *Electric Sax*.

The Rainmaker is a small, hand held, battery powered, single stringed mandolin-looking instrument, capable of producing evenly tempered scales. It has one speaker, and an output jack, it can produce portamento and wave shaping, and its functions are easily learned.

The Electric Guitar Pick is a small device that can be attached to a normal guitar pick. It is very thin and light. When this device is squeezed, it puts out a voltage which can vary any voltage controllable device - such as filters, phasers, and the like. This device will give the live

CONTINUED ON PAGE 35

# COMPOSER/PERFORMER

## TIMBRE MUSIC

Carter Thomas organizes his many workshop and concert appearances from Spring Glen in the Catskill Mountains of New York, but you might run into him anywhere in the country, and his work anywhere in the world.

In 1974, Thomas received his masters degree from the California Institute of the Arts where he coordinated the electronic music studios and studied composition with Morton Subotnick, Hall Budd, and Jim Tenney.

Also at Cal Arts, Thomas embarked on an ongoing, artistic relationship with Dennis Pies. Pies' animation has a startling visual impact and Thomas' music provides an excellent aural counterpart. The combination of these artists has produced to date: *Merkaba*, *Aura Corona*, *Luna Nocturna*, and *Sonoma*. *Sonoma*, funded by a

grant from the American Film Institute, has just been completed and will be released in early 1977.

In 1975, Thomas received a grant from the National Endowment for the Arts, for *Illuminations*, a work for acoustic instruments and live electronics. *Illuminations* utilizes synthesizers not only as a sound source but also as a means of modifying the acoustic instruments. This use of the synthesizer centers on Thomas' compositional process. Carter says, "My music is a timbre based music, meaning that timbral modification is of utmost importance in the structure of the music."

Carter Thomas is currently touring colleges across the United States. In addition to concerts, he is also conducting "hands on" workshops emphasizing not only the synthesizer's ability as a sound generator but also its ability as an instrumental modifier. Both the Serge Modular music system and the EMS VCS-3 are used in the workshops and are fully explored for the benefit of the participants.

An album of Thomas', "Timbre Music", is scheduled for independent release in April 1977.

# and graphics

## technical illustration

" since 1976 "

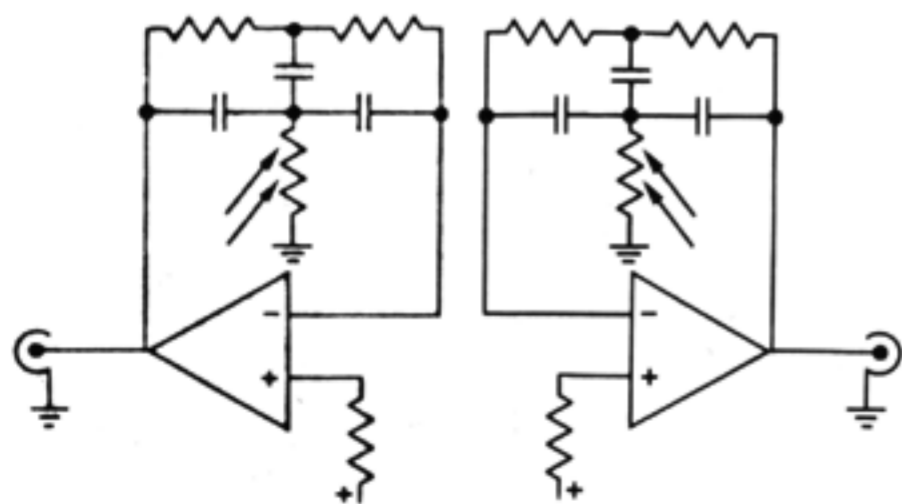

213 « 361 « 6625

1151 MACNEIL STREET  
SAN FERNANDO « CALIFORNIA 91340

# LISTINGS

## MANUFACTURERS

ALAN LABS  
Box 434, Van Nuys, Calif. 91408

ARIES INC.  
119 Foster St., Peabody, Mass.  
10960

ARP INSTRUMENTS  
320 Needham St., Newton, Mass.  
02164

JOHN BLACET\*  
4019 Chico Ave., Santa Rosa, Calif.  
95401

BUCHLA  
Box 5051, Berkeley, Calif. 94705

CFR ASSOCIATES\*  
Box F, Newton, New Hamp. 03858

CONCERT COMPANY\*\*  
3318 Platt Ave., Lynwood, Calif.  
90262

DAVEL  
Box 279, Verdugo City, Calif. 91246

D.B.L. ELECTRONICS  
502 Sherman  
Canton, Mass. 02021

EMu SYSTEMS  
3455 Homestead Rd., No. 59, Santa  
Clara, Calif. 95051

ELECTRONIC MUSIC STUDIOS  
(LONDON) LTD.  
277 Putney Bridge Road, London,  
England SW152PT

ELECTRONIC MUSIC  
LABORATORIES  
P.O. Box H, Vernon, Conn. 06066

FARFISA  
1330 Mark St., Elk Grove Village,  
Ill. 60007

HAMMOND  
4200 Diversey, Chicago, Ill. 60639

HARVEST PRODUCTIONS  
Gregory Kramer  
135 W. Broadway, New York, N.Y.  
10013

IONIC INDUSTRIES  
128 James St., Morristown, N.J.  
07960

KORG/UNIVOX/MERSON  
75 Frost St., Westbury, N.Y. 11590

LYRICON/SELMER  
Box 310, Elkhart, Ind. 46514

### NOTE:

- \* manufacturer makes kits only
- \*\* manufacturer makes both kits and finished product



MOOG/NORLIN  
7373 N. Cicero Ave., Lincolnwood,  
Ill. 90646  
Customer Service: Box 131,  
Academy St., Williamsville, N.Y.  
14221

M M ELECTRONICS  
French's Mill, French's Road,  
Cambridge CB4 3NP, England

MUSITRONICS CORPORATION  
Sound Lab 10, Rosemont, New  
Jersey 08556

OBERHEIM ELECTRONICS  
1549 Ninth St., Santa Monica,  
Calif. 90401

OCTRON  
1346 Bayport Ave., San Carlos,  
Calif. 94070

OZNIE/PROCESS ELECTRONICS  
Box 7, Centerville, Penn. 16404

PAIA\*  
Box 14359, Oklahoma City, Okla.  
73114

POLYFUSION  
6 Cindy Dr., Williamsville, N.Y.  
14221

ROLAND  
2925 South Vail St., Los Angeles,  
Cal. 90040

SEQUENTIAL CIRCUITS CO.  
7150 Rainbow Dr., No. 7, San  
Jose, Calif. 95129

SERGE MODULAR MUSIC  
1107 1/2 N. Western Ave.,  
Hollywood, Calif. 90029

STAR INCORPORATED  
Box 71, Stafford Spring, Conn.  
06076

STEINER-PARKER  
2258 South, 2700 West, Salt Lake  
City, Utah 84119

STRIDER SYSTEMS  
P.O. Box 2934, Norman, Oklahoma  
73070

SYN-CORDION  
32-73 Steinway St., Long Island  
City, N.Y. 11103

SYN-KEY  
spg 117 W. Hintz Road, Wheeling,  
Ill. 60090

SYNTORCHESTRA  
see FARFISA

TOTAL TECHNOLOGY  
see OCTRON

VAKO SYNTHESIZERS, INC.  
4651 62nd Ave., N., Saint  
Petersburg, Fl. 33565

WASATCH MUSIC SYSTEMS  
P.O. Box 9175, Salt Lake City,  
Utah 84109

YAMAHA INTERNATIONAL  
Box 6600, Buena Park, Calif. 90620  
360 SYSTEMS  
2825 Hyans St., Los Angeles,  
Calif. 90026

CONTINUED ON PAGE 8

# SERGE MODULAR MUSIC SYSTEMS

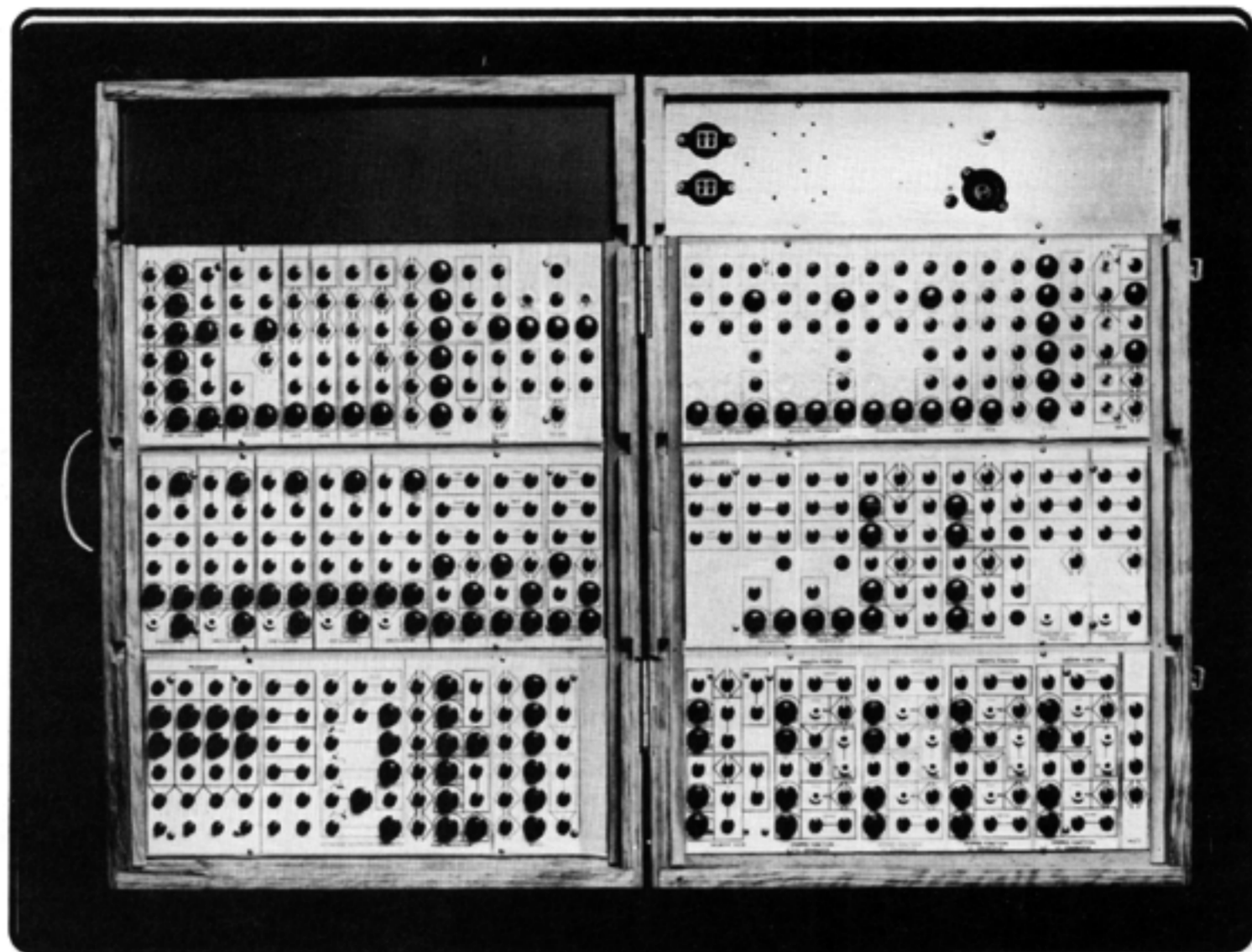

## THE AFFORDABLE STUDIO MUSIC SYNTHESIZER

*If you are shopping around for a synthesizer or thinking of expanding your present system with some new modules, be sure to check us out. We are SERGE MODULAR MUSIC and we manufacture the SERGE MODULAR MUSIC SYSTEM. Our systems represent the state of the art in voltage controlled equipment. Many of our modular functions are unique to the SERGE SYSTEM, and not available from any other source. Moreover, the SERGE SYSTEM is affordable. Module per module our systems cost from half to a third of the cost of comparable commercially available modular systems. Our systems cannot be bought at stores, we sell direct to musicians, commercial installations and schools. Furthermore, we can save you even more money if you buy our systems in kit form. (Note too that our kits are like no other kits. Most of our kit-modules are shipped complete with pre-assembled and tested P.C. boards, therefore ensuring that our modules will work for you right off the bat after you have finished wiring them up). Last but not least, we are offering a 10% discount off our regular prices for all orders (kits or assembled units) postmarked before January 1, 1977.*

*Send us a dollar for our newest catalog (refunded with your first purchase) or call 213-461-7987.*

*We think you will be pleasantly surprised about what SERGE MODULAR MUSIC can do for you.*

**SERGE MODULAR MUSIC**  
Marketing Dept. G

1107 1/2 N. Western Ave., Hollywood, CA. 90029

**MORE LISTINGS**

**CONSULTANTS**

**BECKMAN & ASSOCIATES**  
2117 Yates Ave., Los Angeles,  
Calif. 90040

**ROBERT CEELY**  
Boston Experimental Electronic-  
music Projects  
33 Elm St., Brookline, Mass. 02146  
(617) 731-3785

**DIFFERENT FUR MUSIC**  
John Vieira  
3470 19th St., San Francisco, Calif.  
94110  
(415) 863-WAVE

**EMSA**  
6 Webster Court, Amherst, Mass.  
01002  
(413) 256-8591

**DWIGHT D. GATWOOD**  
Director, Electronics Music Studio  
University of Tennessee, Martin,  
Tennessee 38238  
(901) 584-7402, 587-2281

**LECTRON MUSIC LAB**  
Box 1594, Hollywood, Calif. 90028

**PATCHWORK SOUND**  
Jack Howe  
14759 Hesby St., Sherman Oaks,  
Calif. 91403

**RON RIVERA**  
48 Brighton Ave. #11, Allston,  
Mass. 02134

**STAR TRACK RECORDING  
STUDIO**  
8615 Santa Monica Blvd., Los  
Angeles, Calif. 90069  
(213) 855-1171

**SYNAPSE**  
Box 359, North Hollywood, Calif.  
91603

**CARTER THOMAS**  
Manpel Rd., Spring Glen, New  
York 12483  
(914) 647-9121

**TNY MUSIC & ENGINEERING**  
Route 4, Defreestville, New York  
12144  
(518) 283-2837, 283-2899

**CONTINUED ON PAGE 35**

**•SYNAPSE/STAR INSTRUMENTS GIVEAWAY•**

NAME \_\_\_\_\_  
ADDRESS \_\_\_\_\_  
CITY \_\_\_\_\_ STATE \_\_\_\_\_ ZIP \_\_\_\_\_  
PHONE \_\_\_\_\_

Send to: Synapse Giveaway  
P.O. Box 359  
N. Hollywood, California 91603

— Void Where Prohibited—

**PATCHWORK  
SOUND**



**Synthesizer Specialist**

- discounts on sales and studio session rentals
- instruction
- modifications
- consultation
- production

14759 Hesby Street  
Sherman Oaks, California  
(213) 990-2984 91403

**SUBSCRIBER'S FORM**

**• PLEASE PRINT CLEARLY •**

Name: \_\_\_\_\_  
Address: \_\_\_\_\_  
City \_\_\_\_\_ State \_\_\_\_\_ Zip \_\_\_\_\_

1 year/six issues \$6.00 in U.S.A. & Canada

1 year/six issues \$7.50 foreign rate

**SUBSCRIBER'S FORM**

**• PLEASE PRINT CLEARLY •**

Name: \_\_\_\_\_  
Address: \_\_\_\_\_  
City \_\_\_\_\_ State \_\_\_\_\_ Zip \_\_\_\_\_

1 year/six issues \$6.00 in U.S.A. & Canada

1 year/six issues \$7.50 foreign rate

# **ELECTRONIC GUERRILLAS INVADE BAY AREA**

by Bob Davis

## **CITIZENS ASKED TO REMAIN CALM**

Among the most recent developments in electronic music is a technology which is so accessible that literally anyone can build their own instruments and devices. This phenomenon has been called "guerilla electronics." One of the many Webster's dictionaries on the market defines "guerilla" as, "irregular warfare by independent bands." The independence available to the electronic music "irregulars" is that they are not limited to the products of commercial synthesizer manufacturers. This puts the composer in a new situation of not only figuring out how to obtain a certain desired sound, but of devising a unique combination of wires, solder, and components which will yield an instrument capable of producing this sound. This article seeks to explore the impact and workings of guerilla electronics on contemporary music by discussing the efforts of three bay area composers.

The new technology spoken of earlier is that of the op-amp (operational amplifier) or IC (integrated circuit). An op-amp looks like a little piece of grey chocolate about 3/4" by 3/8". It usually has eight (or at least an even number) or legs symmetrically on two sides. These are the connection points for wires, resistors, or plugs. And best of all op-amps are a result of the technology used to send men to the moon; that is, small, powerful, and very efficient. The op-amps used in electronic music were developed by a large electronics firm for use in some military/industrial projects. Now that they have moved on to more sophisticated components these companies put their designs on the market for others. It's possible to build pacesetters for heart patients, EEG's, and other health related electronics with this same technological overflow.

# GUERRILLA ELECTRONICS

Op-amps are more efficient and precise than is needed within the frequency range used in electronic music. After all, this is only music. It doesn't require the same precision as delivering warheads a third of the way around the world.

David Behrman is a composer who has worked building his own devices since 1965. His inspiration was David Tudor's workings on early electronic music pieces such as John Cage's "Cartridge Music". Gordon Mumma was the first person David knew who built devices; a ring modulator made from a schematic of Gordon's began David's building career. (David and Gordon, along with Robert Ashley and Alvin Lucier make up the Sonic Arts Union, a performing group.)

The technology in 1965 was not yet up to op-amps; at that time, everything was built with transistors. David continued to work with transistors even after IC's became available. "I was afraid of them. I bought some in 1970, but could never get them to work." This is the same problem of fear and later frustration faced by every beginner in electronics. Eventually, in 1972, David found that op-amps really opened up simpler and quicker ways to design equipment. "It's so easy now compared with what it was 10 years ago. One transistor doesn't do anything, but one op-amp does!"

There are several reasons David gives for why he began designing his own equipment. Access to synthesizer studios was difficult if one wasn't associated with some academic institution. There was the problem of wanting to take the equipment with you "like a clarinet". Most synthesizers were not suited for concert use and even if they were, it would probably have to "be back by 9 A.M. Monday." Finally, the designer, by making decisions of what goes into the synthesizer, limits the choices available to the composer using the system. The designer almost writes the piece. "I think of the early Buchla synthesizer music

of Morton Subotnick as the Buchla music of that era, particularly because of the close collaboration of Subotnick and Buchla." These built-in limitations are not only present in early synthesizers, but also in many of the systems marketed for use by popular music groups.

David's most recent design project is an electronic music-video-sculpture installation done in collaboration with Bob Watts and Bob Diamond. It's titled "American Sky" or "Cloud Driven Music". A video camera is pointed at the sky and the image displayed on a monitor. This monitor is specially equipped with six adjustable lines which form three cross hairs. The amount of light present in the sky at the intersection of these cross hairs determines a voltage which is sent to David's homemade electronic music system. This device contains a master tone generator from which all the sounds are derived. By multiplying and dividing the very high frequency of this generator, a mean tone scale in several octaves is produced. These notes are then organized into six three note chords. As the voltage produced by each of the six cross hairs changes, these pitches are sent spinning off in cloud written counterpoint until they again come to rest in a different chord.

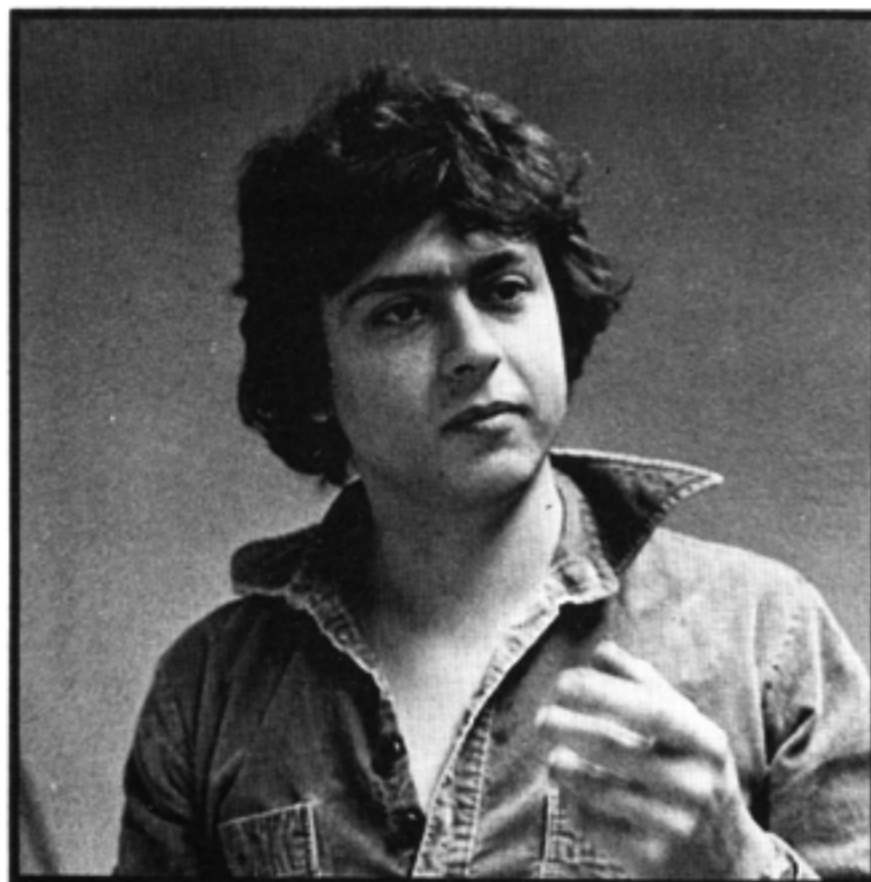

Paul DeMarinis.

Another option open to David when he designed the device, would have been to use a "chip", (familiar term for IC's or op-amps) which is used to produce the sound of an electronic organ. The chip produces only the top octave itself. All other sounds are made by dividing the frequency by different amounts for the lower octaves. Therefore, the chip is like twelve oscillators; one for each of the tempered notes in the octave. And there's the rub. It was thought that the mean tone tuning would be more suitable for the sky driven music. Using the tempered scale "would be like buying fresh food with preservatives."

Also working in the bay area is composer/designer Tony Gnazzo. The problem of giving the illusion of movement to a sound on a quadraphonic recording or playback system attracted his attention. He was teaching a class in "gadgetry" as he calls it. Most of the people in the class were electronics freaks who wanted to build their own synthesizers. They asked Tony to find a system for rotating sound in four quadrants.

Sound location has been interesting to many since before the inception of stereo. Perhaps the most detailed solution is John Chowning's computer program for sound location developed at the Stanford University Artificial Intelligence Center. The problem is that this solution, which seems to cover all bases, requires more extensive digital or computer hardware than is available to most composers.

The basic problem is that as a sound moves through space it should not lose any of its volume. The usual solution for professional audio engineers sends the signal through four potentiometers and a joy stick. This joy stick is only controllable manually; it's really a part used for controlling model airplanes. "Everybody sells the same one made by the same manufacturer. He sells them for about \$17.00 and I've seen them re-packaged and selling for six times that for audio uses."

Virginia Quesada

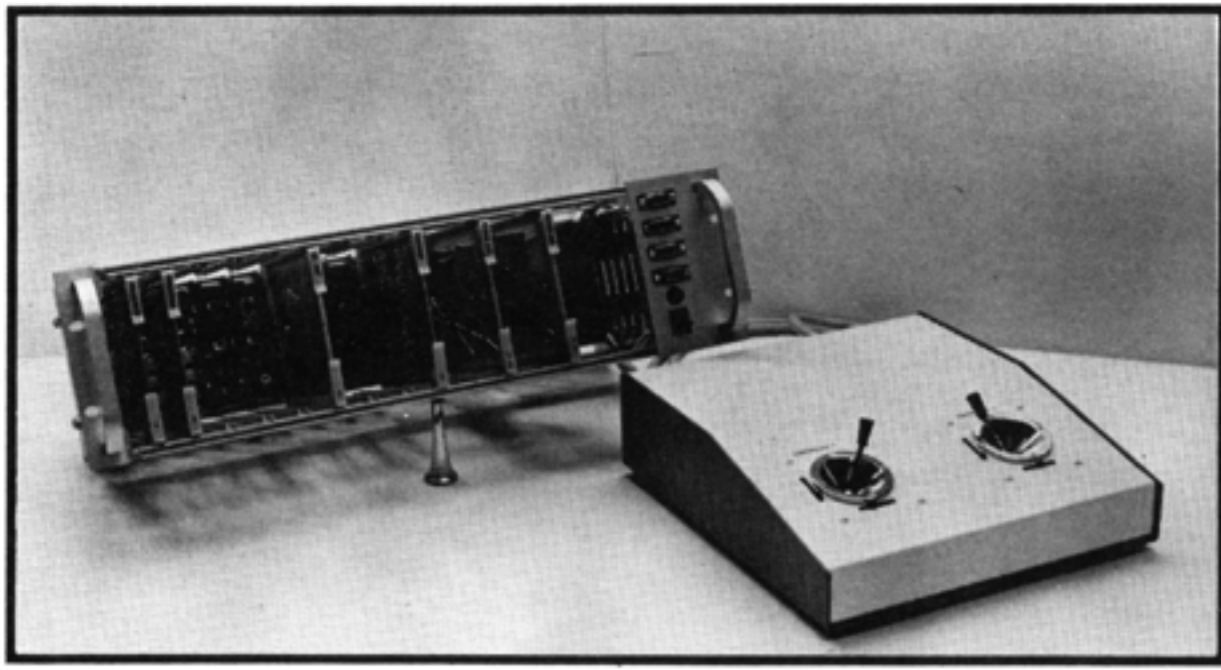

Tony Gnazzo's quad-panning device.

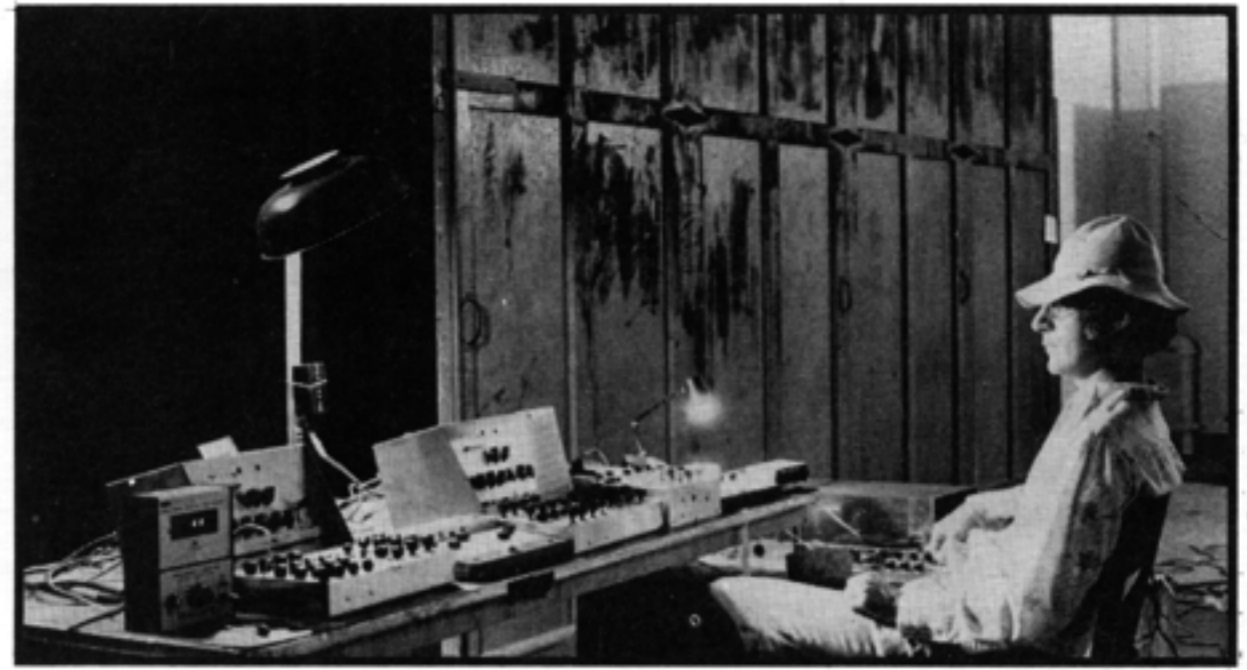

David Behrman.

Virginia Quesada

Tony's solution for his Quad Panner does not route the sound through the joy stick at all. Instead it goes through four voltage controlled amplifiers, (VCA's). The joy stick is a voltage source sending a series of four coherent control voltages to the VCA's. If designers completed the circuits to do this, it would mean the end of the project; but, much more was considered here. For starters, the joy stick itself is voltage controlled. There's one voltage input for moving the sound from front to back and one for right to left. Also, it's compatible for control by both digital and analog devices. The four VCA's can be disengaged from the joy stick should they be needed for other uses. If audio signals are put into the left-right, and front-back control inputs, the four VCA's act like four ring modulators which are out of phase with each other. In order to assure that the panner will operate compatibly with any synthesizer, the resistors plug in and out. Tony has tried his device with Buchla and Moog equipment by plugging different resistor values; the results were excellent.

After finishing the designs, Tony had circuit boards made which he has been selling to various studios. So far, the boards for this device have been purchased by The San Francisco Conservatory of Music, Harvard University, The Center for Contemporary Music at Mills College, City College of San Francisco, University of California at Berkeley, California State University at Hayward, and California State University at San Francisco. Slightly different versions can be found wherever this device is in use. This isn't because of a conscious evolution; as Tony puts it, "My process of evolution has to do mostly with house cleaning." The present result of this house cleaning mixes 16 inputs through four

sets of VCAs each with its own joy stick controller. The result is four sounds moving independently around the space.

So is it finished? No. "This year's project is to build a panner with a micro-processor so the user can sit at a small typewriter and program a sound's movements with digital exactness." In all of this, there's one major consideration, something that all designers should keep in mind, Tony says that he'd rather, "build a reliable machine that works every time, than one that's very complicated."

As complete and well thought out as Tony Gnazzo's designs and devices are, he tends to keep this separate from what could be termed his more artistic endeavors. Regardless of how sophisticated the technology he's working with is, he says, "My dealings with these problems is somewhat trivial compared to what I consider esthetic considerations."

Wouldn't it be a boon to modern man to have an electronic music maker which would replace the car radio? Running on the power of the car's electrical system, it would play ever changing phase music based on a pentatonic mode. Such was Paul Demarinis' thought in 1973. Thus he built the 'Pygmy Gamelon.' It's called "Pygmy" not only because of its size (a mere 1" x 4" x 7"), but also because the music resembles that of the pygmy people. That is, it uses a few different pitches and plays rhythm patterns with them. The "Gamelon" comes in because the word gamelon refers to a collection of instruments, not players. If someone says, "Look, there's the Chicago Symphony", you'd expect to see a group of people. But if you hear, "Look, there's the Venerable Dark Cloud Gamelon Orchestra", what you'd see is the gongs, bells, stands,

and other instruments which make the music. The "Pygmy Gamelon" is, "a hardware piece". It's for, or of objects, rather than people. As Paul says, "Anything else besides that 1" x 4" x 7" box is just talk, except the power supply."

Since this article is just talk anyway, it might be interesting to look into the box itself. There are five tuned resonant filters which are resonant almost to the point of feeding back. A pulse sent through any of these filters produces a "pinging" sound. The pulses are controlled by a "carp" device. It acts like the fish - the carp; which scavenges and eats anything it finds. This electronic carp picks up on, and eats any stray electrical field in the vicinity. Fields surround wires, appliances, and just about any current anywhere. The amount of this current controls the pulses. The result is that, not only is the gamelon somewhat random, but its randomness is responsive to the environment in which it is placed.

Paul is traveling at this time with David Tudor and several other young electronic music composers, (John Driscoll, Phil Edelstein, Bill Viola, Ralph Jones, and others), to present new pieces in Paris. The "Pygmy Gamelon" will ring its small quiet sounds for a whole week at the *Musee Galliera*. It is also possible to create an ensemble of many "Gamelons" with an external clock; in Paris many of these small boxes will be connected in this way.

Electronics has been a concern of Paul's ever since 1972; that time he built several oscillators to act as a drone. He used this to practice East Indian Raga singing which he was studying with Pandit Pran Nath. David Behrman provided him with the schematic to build these electronic

CONTINUED ON PAGE 32

An  
Interview  
with  
**BOB EASTON**  
President & Founder of  
**360 SYSTEMS**  
with  
Angela Schill

**Synapse:** "What's your background in electronics and design and what was your first introduction to electronic music?"

**Bob Easton:** "I have no formal background in either. I do in music; I played violin for ten years. Electronically, I'm self taught. I've been messing with electricity, honestly since when I was four year old. My dad bought me some batteries and some wire and a little electric motor. You could hook them up different ways and make different things happen. I thought that was pretty hip stuff. When I was in high school, I built a television camera that could see in the dark. We put it in bedrooms at parties and hooked it up to the TV set. Nobody had television cameras at that time, this was about 1961. Then I went to college and didn't study electronics and didn't study music but did get into cinema. Then the film business got me into the music business. I did some work with Frank Zappa, whom I met around 1971. Then I went to work for a while as an electronic engineer, I designed the first automated mixdown system for a small company. I designed a digital delay line which is used in studios a lot now. They made the mistake of paying me too well though, and I saved all my money and started

my own company with that money and bought my equipment and all my materials and got rolling.

Within a month after I started, I was shipping my first pitch followers. Shortly after, I started making frequency shifters; kind of rare esoteric things out of the early days of electronic music. Moog was going to make them and they never did until much later.

The frequency shifter has done pretty well, we're still making them today. They're used somewhat on Larry Fast's albums. Then, guitar synthesizers came along. So chronologically, we have a pitch follower, a frequency shifter, and a polyphonic guitar synthesizer.

How I came to get into the business that I'm in now is essentially a process of: interested in electronic music, but bored with it in the form that it had existed in

I first encountered synthesizers about 1969 or '70. I probably heard Walter Carlos' work initially and then I heard some work around 1970 that a guy named Paul Beaver did. I went to the first convention where ARP demonstrated their synthesizer and I thought that was really interesting. They let me play it for hours. I got really interested

Bob Easton, the president and founder of 360 Systems, has bravely gone where no man has gone before: into the world of guitar synthesis.

Aware of the special technical needs of electric guitarists, Easton set about to develop the first guitar players' synthesizer that would both challenge and satisfy the musician's imagination.

Today, he has successfully designed and marketed the first guitar synthesizer interface, along with a pitch follower; a frequency shifter; and his latest invention — the economy-minded "Slavedriver" guitar synthesizer. While acknowledging the importance of non-commercial synthesis to the development of electronic music, Easton nonetheless keeps his eye on the more popular side of synthesis and its contribution to rock and roll.

and thought, How do you turn these into musical instruments? They're sort of half way between a laboratory curiosity and a live performance thing. But, in no sense can you take any synthesizer, including most of them made today, on stage and use it live without being scared. Most of them don't stay in tune, they've got a billion patch cords. There are all kinds of reasons why they're something less than variable. And then it occurred to me that the people that are really stars in the pop music business aren't the keyboard guys so much as the guitar players.

The keyboard synthesizer business was really well tied up then. It's very competitive and everybody in it does only moderately well. They're having a rough time out there, every one of them. Then I thought well, for all the people that play keyboards, I'll bet you that more people play guitar than everything else put together.

About 1973 I came out with my first product which was a pitch follower that was for single line musical instruments. It worked really well with things like saxophones and flutes and some brass instruments. The idea was that you could plug into it and play a synthesizer; you could use it as a keyboard replacement.

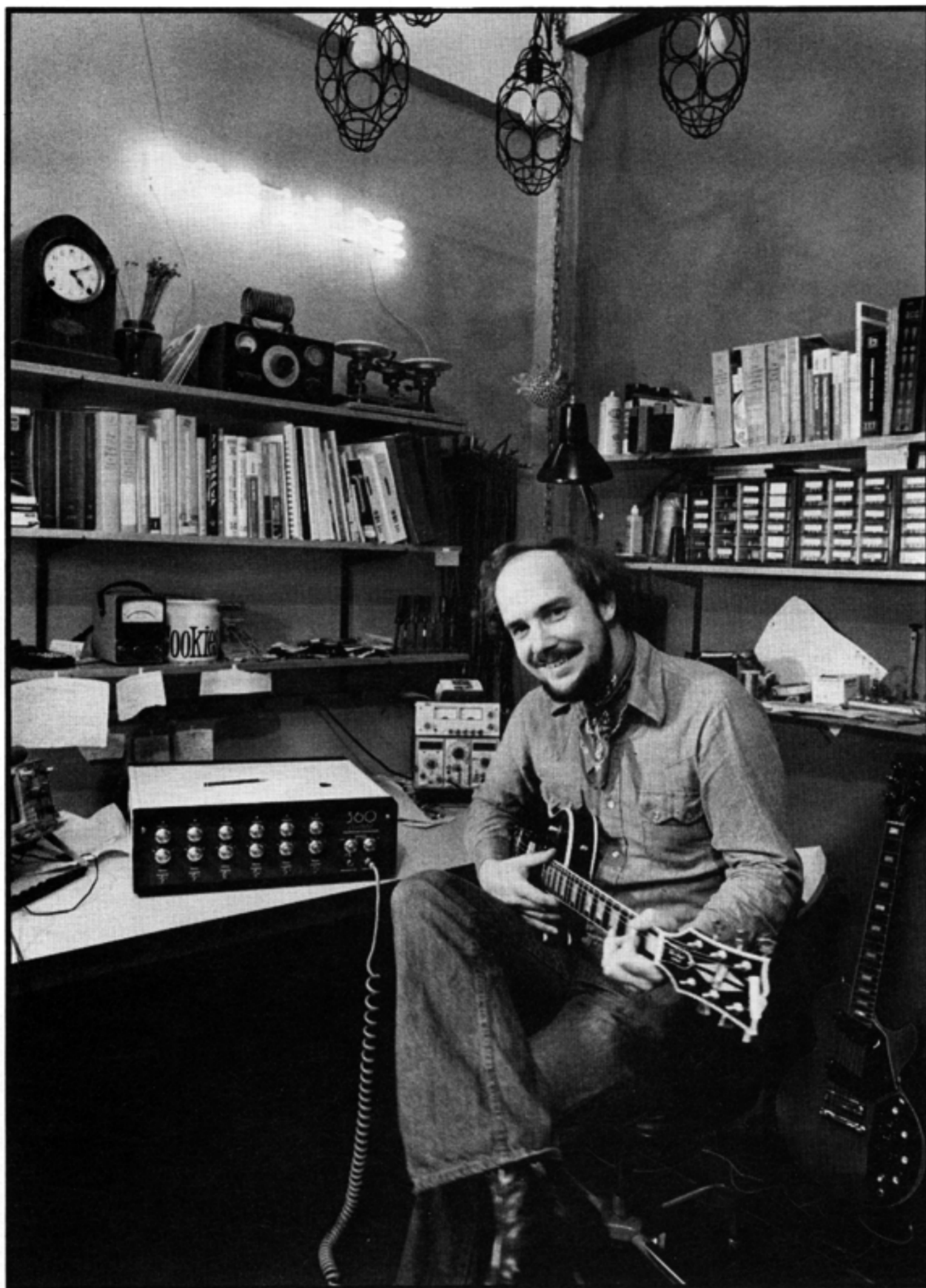

Bill Matthias

Bob Easton, president of 360 Systems, with his guitar synthesizer.

It would copy the pitch you played, the dynamics of your performance, and you could trigger filters with it. You could use the synthesizer to back up the really fat sound that a live acoustical instrument has. You have a really magnificent sound, and the combination of the two will blow out any synthesizer that's been made, simply because you've got one complex live sound at all times in addition to the synthesizer. That product sort of cruised along for a little while.

Then about two years ago. I designed and assembled my first

polyphonic guitar synthesizer and I guess I have the distinction of actually marketing the first polyphonic synthesizer anywhere. It was a guitar instrument, it drove six Oberheim Expander Modules. So actually it would be fair to say that I produced the first guitar synthesizer interface. It's capable of driving any synthesizer, and subsequently, we sold a number of them. Some of them drove EMu systems, and one of them drove six Minimoogs and the balance of them drove Oberheim synthesizer expander modules in a slightly modified form. Those were the most

successful in terms of staying in tune, price, performance and manageability. We're of course, very enthusiastic about the future of that particular synthesizer in light of the synthesizer programmer module just now being available. I'm really directing all my activities toward live performance instruments."

**Synapse:** "Aimed more for performance than the studio?"

**Easton:** "Very specifically, because I really think you can always do a better job later. You can always multi-track things with a little Minimoog and come up with a great big sound.

I really feel that if we look at all the instruments today and we look at the scheme of things, the successful performing musicians come in and tell me what they want to do and we find that they want to be able to do things live. They want to make a magnificent album sound and that's extremely important to be able to produce live and not sound flimsy.

The other thing is that, guitar players really rule the rock and roll business and I'm going to continue to talk about rock and roll and pop music because of the fact that 99% of the money that's made in the whole music business is from pop music. It's not in classical, not in experimental music, and very specifically is not made in electronic music."

**Synapse:** "So you would be more interested in promoting the use of your instruments more for the rock and roll world rather than in Electronic music?"

**Easton:** "Well, I don't believe that electronic music is something that stands alone and apart from the rest of it. I don't think it has any future, except as it relates to commercial music. I mean I dig that there are concerts held in an academic forum, and some of that I'm very interested in in terms of exploring frontiers."

**Synapse:** "Anything specific?"

**Easton:** "No, I don't like most of it but I'm really glad to see people doing it because I see little ideas coming and then I see people pick them up and explore further. The

CONTINUED

MORE  
Easton

guys that really come up with music are the ones that don't have the burden of turning it into a dollar every minute that they're awake. But frankly, really speaking in terms of what I'm interested in, I would have to say that I really find the majority of electronic music boring and ten years old. It's getting to be split in fact. A guy like George Duke buys himself an Odyssey and he gets up on stage with the Mothers and he does an incredible keyboard performance and blows people out and it's great. But now this is not the Odyssey that did it, in fact, it doesn't have anything at all to do with it. It could have been anything else. It's George Duke using an instrument and that's synthesis having come of age as I see it. It's happening in live performance and Arp has an instrument going there in George's case which is every bit as valid as a Moog or anything. Nobody knows what it is he's playing, and they could care less. Then the opposite extreme that kind of irks me is producing noisy little compositions, personal musical statements which have no proper place in the public light yet they're put upon the public. It's what Harry Partch called the halls full of old blue-haired ladies that sat there and applauded politely and they didn't know what they were applauding for. This is my own cynicism about electronic music."

**Synapse:** "Do you think it's not progressing or do you just not like the way it's being used esthetically?"

**Easton:** "I like the way it's used only in connection with a very small number of works. I really think it takes a special kind of person to play it. When you start to learn to play a musical instrument you have to find the right instrument. Only some learn to play their instrument well and most of the rest give up. But anybody can learn to play the guitar a little bit, but hardly anyone becomes good, and I think it's true of synthesizers. You learn to get into them a little bit and you're no more interesting than the average guitar player. Yet it's very,

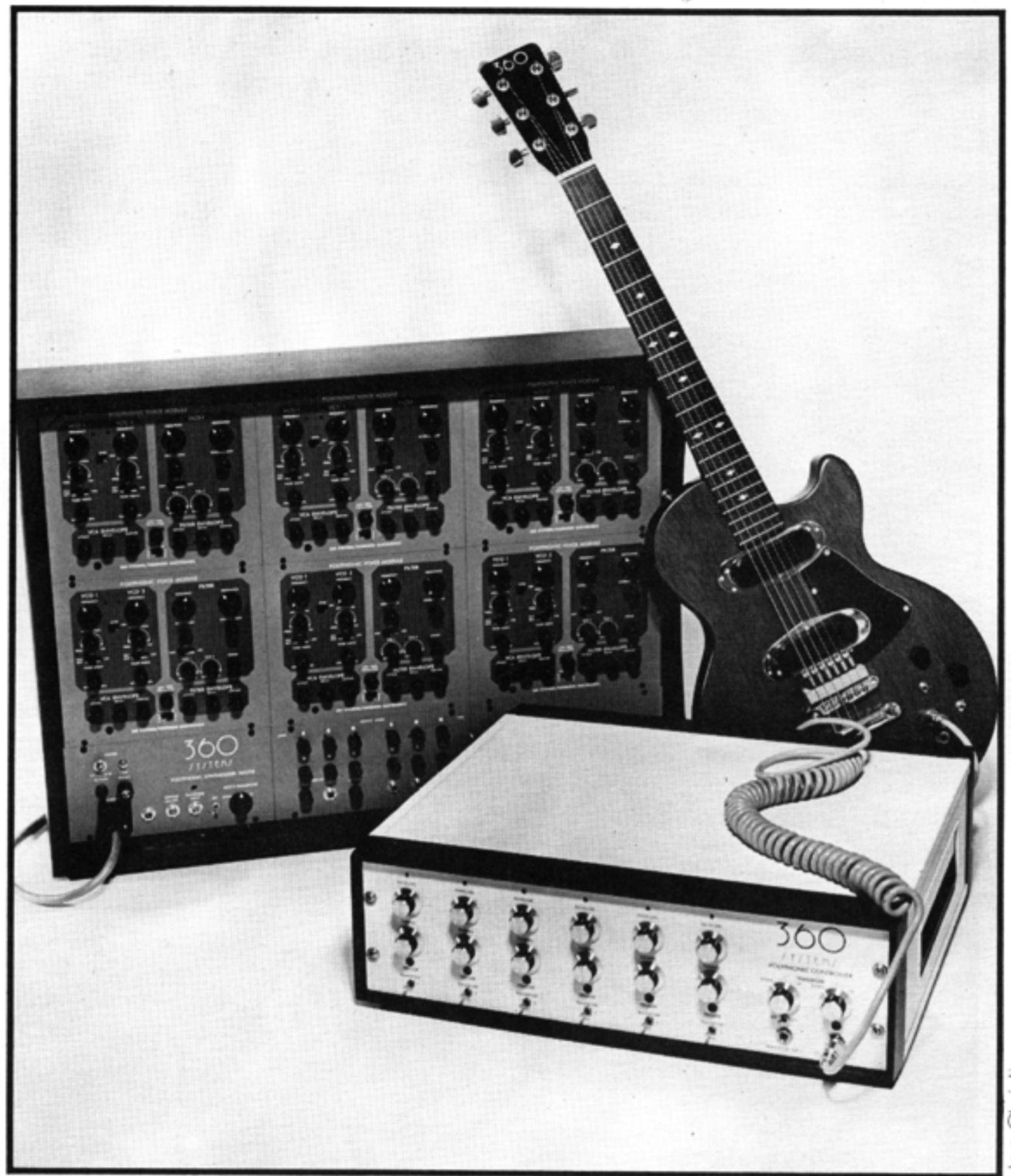

360 Systems' Polyphonic Guitar Synthesizer.

Jon Christie

very, hip to play synthesizers. Some kids buy musical instruments to emulate musicians that they idolize. Probably everybody in the world would buy a synthesizer if they weren't so expensive, but as it is, there are tens of thousands sold and very few people learn to play them well.

"They do use them in live performance and badly on albums, whereas if you learn to play a guitar badly, you do not use it on an album. It's because you don't feel called upon to use it, but musicians do feel qualified to use a synthetic noise at every turn. Certain musicians really become very proficient on the synthesizer. For example, I just sold a guitar synthesizer system to Lee Ritenour and Lee has no prior experience with electronic music but he has a beautiful sensitivity to

the synthesizer. He comes up with sounds which compliment his guitar playing styles. He's sort of a jazz guitarist, and I'm very enthusiastic about what he's doing. But then, I sold one to John McLaughlin and it just didn't happen with him."

**Synapse:** "Is he still learning on it. I don't ever hear him playing it."

**Easton:** "John doesn't play electronic music, he doesn't play electric guitar even, he plays Indian music of an acoustical nature. He threw in the towel on the whole pop music business, left his wife, shucked his guru, and moved from his house; he's changed everything."

**Synapse:** "Is he using your system for his own use or do you think that he'll come out with it later?"

**Easton:** "He doesn't use it. I



would be willing to work with McLaughlin at such a time as he gets back to playing jazz rock. You know, the fact that music hasn't yet come out of him with that instrument doesn't mean that it won't."

**Synapse:** "I've heard mentions of John Anderson before and also that Steve Howe has your system."

**Easton:** "This is a funny story. There's this guy in New York City; he's supposed to have been working on a polyphonic guitar synthesizer for years, but when ever you go back there to see it, you can't for some reason; it's not working, or this and that. Then there were some rumors that Steve Howe was going to use it on an album, it just didn't work. They said it didn't survive transportation to the studio!"

**Synapse:** "Was there anybody else around that started on this idea but never made it; have you heard of anyone else doing this?"

**Easton:** "Yes, I've heard of a very large number of people, probably as many as six or ten. But I'm the only person who's ever sold them so far."

"There are some severe problems in making those things. I'm an expert in an area of signal processing called 'pitch extraction,' which is the process of determining the true pitch of a very complex noise. When you pluck a guitar string, you've got to find the exact pitch of the string. You have to find it fast, you can't wait, you can't give the machinery a while to make up its mind."

**Synapse:** "Then the frequency follower is the gist of the whole system? That's where you make or break it?"

**Easton:** "It's a systems problem also of the various kinds of guitar synthesizers that have been made, you have to really define what it is that you're going to do. In other words, by what means is the guitar going to play the synthesizer. Now, guitars make kind of funky little noises, they don't have a very wide vocabulary of attack-decay possibilities. So we had to devise a way to get triggers out of the guitar system and into the synthesizer where the trigger specifically reflected a given activity on the guitar. In the case

of our system when a flat pick leaves the string, a trigger comes out. We use an ordinary old tortoise shell flat pick and an ordinary old guitar. But if you hammer on and pull off with your left hand, you will not produce triggers, if you pick with your right hand you will produce triggers. So this gives the player a very high degree of control over the filter's activity in a synthesizer.

"I've thought quite a while about what the thing ought to do in terms of control and I got just an enormous number of studio musicians and performs in and took a lot of feedback from them for quite a while. I would have to say that I didn't design my system as much as the professional people in this town designed it. I try to keep in close contact with what's going on, I'm not an entirely good guitar player incidentally, and so I really respect the people who are good guitar players. If McLaughlin tells me that it's got to do this and that then I'll listen to that, for sure. I know more about guitar synthesizers than someone does that hasn't got one. So, what I ask them to do is to buy this as it is and then let's talk about things downstream. I would like to incorporate good ideas into everyone's."

**Synapse:** "Who do you really respect as a guitar player? Also who would you like to see using one of your systems that doesn't use one now?"

**Easton:** "I wanna hook one up to a steel guitar and I wanna hear Buddy Emmons play. Buddy is one of the great country music steel guitar players. I would like to hear Jeff Beck play one of my instruments sometime. Jeff encountered it for the first time a couple of weeks ago. I'd like to see Pink Floyd and Steeleye Span use it; those two could really use it well. Then there's always Frampton . . . I'm going to sell one to Montrose one of these days, he doesn't know that but I'm gonna go get him."

**Synapse:** "What are the big name professionals out there that are using your system at this point?"

**Easton:** "Leon Russell, you know, Leon doesn't play guitar in public but he does in private."

**Synapse:** "A lot of them are using it for their own enjoyment?"

**Easton:** "Yes, and for album work. One of the acts that's really exciting is a record that came on the charts at 85 with a bullet last week. It's called "Symphonic Slam" by Timo Laine. His act revolves around the guitar synthesizer. He's an outstanding guitarist, I don't know quite what to compare his music to. He's a really loud, rude, rock and roller, and he gets an energy level going that is really ferocious. It's the whole process of using loud, rude, electronic instruments to project that kind of thing that guitar players project anyway. I predict that Laine is really going to go some place with it. There's a guy named Tom Seuffert and he's got a group called "La Seine" like the river, and he's doing some neat stuff with it. Lee Ritenour I think, is really good. I think these three guys, Laine, Seuffert, and Ritenour are really the people to watch out for, they have the capability to go someplace."

**Synapse:** "When someone first buys your system, do they start using it with its full potential?"

**Easton:** "There's a problem in terms of what you'd have to call 'lessons.' In learning to play a synthesizer, there are certain problems related to humility. You have to admit, 'I don't know how to do this'; and so you have to get someone to show you. McLaughlin and Zappa are not made up in such a way that they'll get somebody to show them, nor is Leon. For this reason I think that they don't fully understand how to program any synthesizer. Mine behaves the same way as any regular synthesizer, except you have an extra requirement; you have six of them. So you must therefore know how to orchestrate. If you're not a good orchestrator, you'll get alarming dissonances and clashes of timbres that make people want to run out of the room and this often happens."

**Synapse:** "Does the orchestration take a long time to learn for the people you sell it to?"

**Easton:** "No, as a matter of fact, it takes a surprisingly short period of time. Most people learn to play

CONTINUED

## MORE EASTON

it really learn, hey, quick — like in a few days.”

**Synapse:** “A *Time* magazine article once mentioned a popular guitarist using one. It said he was overcome a little bit by the price, and secondly, by the fact that he felt he needed at least six months to sit down and learn it.”

**Easton:** “John McLaughlin said that. But, he estimated that it would take six months to learn guitar synthesizer technology — as a quote from the *Time* article. Now, John played in this room for ten hours and really got a very good handle on the synthesizers. He declined from that point on to personally twiddle knobs himself but rather hired a knob twiddler. John played for five hours on two successive days here, and broke light bulbs and stuff with the sound level. After that, I really felt that when he left he knew what he was doing. But the guitar synthesizer isn’t hard to learn and it’s all essentially the same thing six times over. On the 360 Systems one, there are many adjustments which happen in parallel, so you don’t have to adjust all knobs six times over. For example, the tuning is in parallel, the filter cutoff frequencies are in parallel, the envelopes can be set at parallel on all of them; this is even without the programmer. With the programmer, everything can be set in parallel.

“I think I was very fortunate in just happening to hit pretty close to the right thing in the first place. But, now I know how to prune it down. I have a system in mind which is very economical, very simple, and has an incredible music producing potential; probably more than what we have now, but at a small fraction of the cost.”

**Synapse:** “Aside from the fact that guitar players would obviously choose playing a guitar synthesizer over a keyboard controlled synthesizer, are there any specific advantages of having a guitar triggered synthesizer?”

**Easton:** “Yes, there are, a guitar synthesizer doesn’t sound like a keyboard synthesizer. I’ve built

and compared the both of them, and the difference is that a keyboard synthesizer stands out because of an extreme levelness and purity of sound. The notes sit there at the pitch they’re at. If that pitch is modified, it’s with the pitch wheel, or an oscillator or something like that. But keyboard synthesizers are not touch sensitive; it’s nothing but a whole bunch of switches and you have no capability to express yourself beyond opening and closing key switches.”

**Synapse:** “Then you have a dynamic touch control on yours?”

**Easton:** “We have. We can control the filter by how the string is plucked; the dynamics, by how hard it’s plucked; you can play loud or soft; you can take the guitar envelope and modify it so that we can attack slow and die out quickly; we can control the timbre as a function of how we pick the string also. Additionally, you can slide on this guitar, you can bend strings; you can bend ’em with your finger; and then you can bend them some more with a foot pedal. On McLaughlin’s album, you can hear him bend up a good third with his finger, and then when he can’t bend it anymore without breaking the string, he takes it up to a twelfth with the foot pedal. It’s great, nobody knows quite what’s happening.

“A guitar is a really great polyphonic controller, and I think that everybody needs to stop and take a good hard look at it. We kinda shy away from guitars because not many people really play them well but it is possible to play a guitar well and it is a dynamite expressive controller. It’s one of the very few ones there are that is easy to learn to play, and that is very versatile. I don’t think the concept has really been explored very far yet.

“We also process the natural guitar sound through filters and VCAs. So for example, I can produce harpsichord or banjo without any oscillators at all.”

**Synapse:** “Is there ever going to be a pre-set guitar synthesizer?”

**Easton:** “Yes, close in the future.”

**Synapse:** “What’s your opinion of pre-set synthesizers?”

**Easton:** “I can’t abide them. Actually there are a number of ways to do it that would make sense, but there’s only one that’s in production right now. It happens to be Oberheim’s programmer. My feeling is that, back room technicians have no business setting pre-sets and telling performers what noise they’re going to use. It’s much too limited. This is no better than buying an organ, which you buy for the noises it makes.

“In the future, though, Emu has something coming out, Tom Oberheim has it coming out, and I presume others are on it too. That is exactly what our guitar synthesizer will have. It’s essential that it have a programmer, because there are too many ways to play the guitar; I think it’s presumptuous to tell other people what they’re going to sound like.

“I like the ability of electronic music to produce new sounds. I’m sorry to see someone grab a synthesizer when it would be more appropriate to grab a clavinet or a piano or something else. What I’m interested in is musicality first and instrumentation second. You don’t use instruments that you just happen to have in your back yard, even if they’re unsuitable. But we do this with electronic music, and that is a fallacy, there’s a whole belief that’s never been killed off that says that a synthesizer can produce any sound. That’s untrue, it can’t, it’s a poor imitator.

“If you want to be critical about electronic music, I think you have to place some merit on the things people do, there are guys that do exciting things with it and then there are people who have really thin concepts that don’t hold water. I could hear Joe Zawinul of Weather Report play synthesizer all day long. A lot of people are doing neat stuff in electronic music, but I think it makes up about five percent of it.

“I really believe that we’re getting to a point where minimum synthesizers will be bought by the people who are just getting into things and that these synthesizers won’t play a very big part any longer in commercial music production. I think the Polymoog

CONTINUED ON PAGE 33



Bill Matthias

**Malcolm Cecil,** composer, performer, programmer and producer has been heard on some of the most influential albums of our time, among them “Fullfillingness First Finale” and “Innervisions” by Stevie Wonder for which he and his former partner Bob Margouleff received a grammy for the best engineered non-classical recording of 1973.

Malcolm’s instrument TONTO has been seen the world over as part of the environment for Ken Russel’s film “Phantom of the Paradise.”

Turn the page and find out why Tonto’s headband is expanding.

**Doug:** "How did you get started in Electronic Music?"

**Malcolm Cecil:** "My original instrument was keyboards way back when you could count my years on one hand. My mother who was a brilliant keyboard artist played the pre-runner of the Hammond organ called the Nova chord. She used to play it professionally during the war at a dance hall. And so, from very, very young I was exposed to the sounds coming from the keyboard. In fact, the Nova chord is more like the synthesizer than the Hammond organ; it had a lot more variables on it and it was a lot more electronic in generation and so on. I think it is one of the transitional instruments between the organ and the synthesizer.

I was exposed to my mother operating this thing by sitting next to her as a very young child and I must have absorbed a lot of this. There was nothing else to watch but the people dancing and I was into music. So I used to delight, when she wasn't looking, to turning the knob that turned off the sounds. She would have to look around for it — you know, little kids' tricks.

By the time I got to the age of about thirteen, I was interested in dancing music. One of the things that really bugged me was that I could never find a good bass player to play with. So I figured, here is an instrument that's very neglected. Here's the place I can excell.

By the time I was sixteen, I had saved up enough money, got myself a bass and really got stuck into it. This is what the world endowed I should play. This is my instrument and I'm really going to get into it. Meantime, still at school, still studying, still passing exams, going on to advanced studies, physics and so on — and two minds. What am I going to be? "Obviously you're going to be a scientist or at worst an engineer," my parents thought. But if you asked me? Well, I enjoy playing. I'm going to be a musician. "But you've got to have something behind you," so I got pushed to be responsible. "You've got opportunities second to none, go to the universities, get your degree and then you can work on being a musician if you want to."

Those are the standard arguments. I stuck it out as best I could and did a reasonable amount of work

towards it. But as time went by, it became evident to me that I was much more interested in music than I was in science and math. What I did was, work more and more, and harder and harder and eventually got myself in the position where at the age of nineteen, I was voted in the Melody Maker poll as number 3 in the country as a bass player.

I was playing with the Bill James trio at that time, it was one of the top jazz trios in England. That, of course, was one of the hottest periods for me as a bass player and what happened was the inevitable. Dr. Fewks failed me on thermodynamics, not in the

going around playing music when you should be studying. We'll teach you a lesson for it. So they put me in the Forces.

Eventually, the Air Force put me into a category which was as low as you can get and still be in. All the disadvantages. They had to put me in trade group number two and I had the choice of going into radio or radar. I didn't know anything about radar so I said, "OK, I'll go for radar," knowing they would have to train me. So they put me on a nine month course, which I passed out of with merits, and they ended up trying to get me to be an instructor. At that

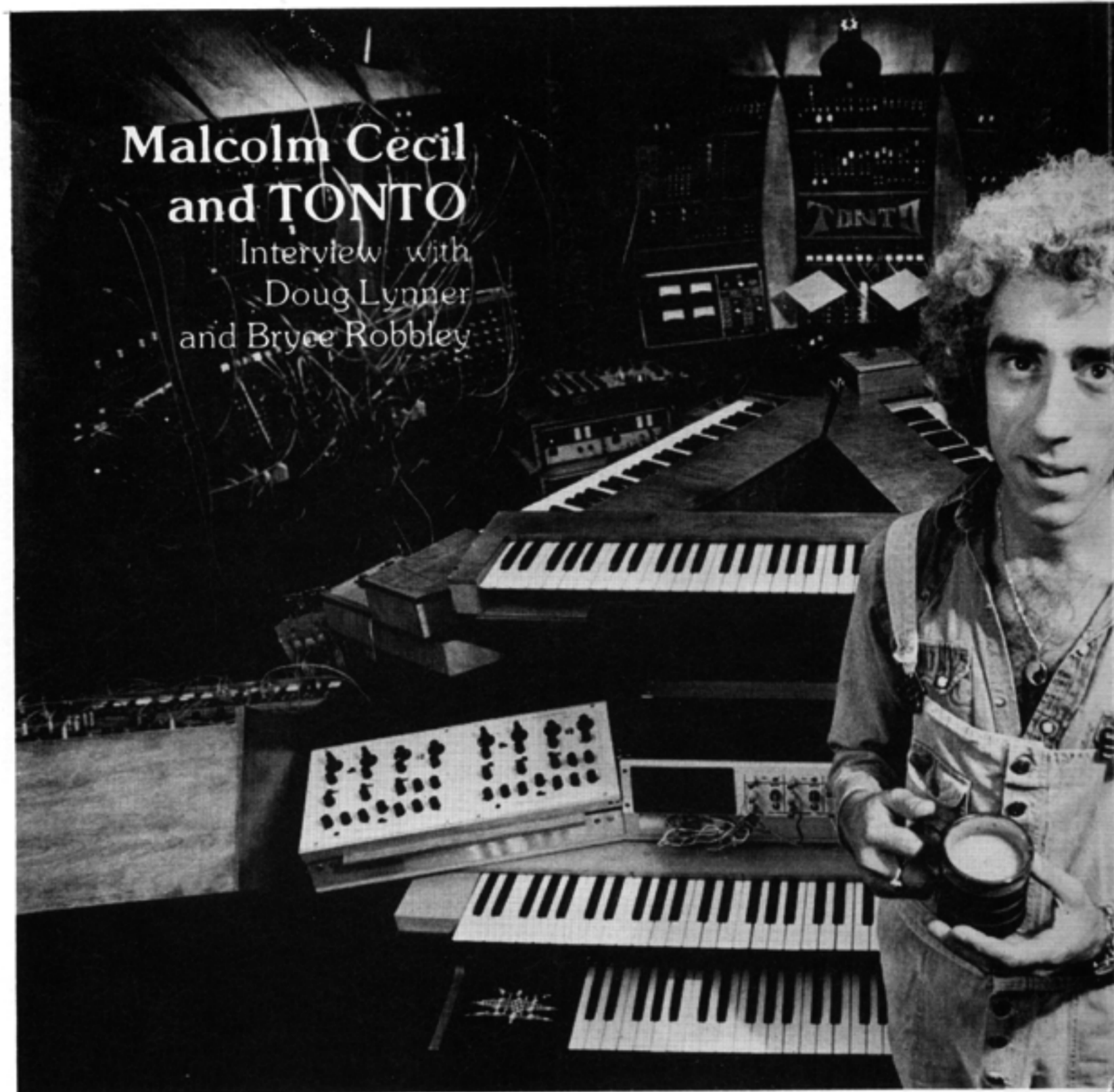

examination but on attendance. He had found a rule somewhere that said I had to attend sixty percent or more of his lectures, otherwise my deferral from the Armed Forces would be discontinued. It made no difference that he banned me from his class. "You've got to go in the Forces," my principal said, "a couple of years in the Forces will straighten you right out laddie. Make a man out of you." Really what they were telling me was — stop your antics

time, I couldn't be anywhere nine months and not start something in music. So I started this jazz club and I wanted to stay there so I got this job as an instructor — helping the educational guy teach sergeants basic arithmetic, english, and stuff.

They were overstaffed, so after two or three months just fooling around trying to find out what the situation was going to be, they finally posted me to a research unit where I'd learn still more because now there was

equipment that was totally unique and that's where I first ran into DC control voltages and analog situations. I started having practical situations with a plotting cable and computers getting into all sorts of interesting automatic antennas that would track aircraft, all sort of stuff that was research level at the time."

**Bryce:** "What year was this?"

**Cecil:** "It was '58; came out in '61. The equipment then was a little more primitive. There were no Moog synthesizers, but then I didn't know I would be a Moog synthesist. The music was still the bass and jazz clubs and so on. That's when I met



Bill Matthias

Mike Jeffries who was to become Hendrix's manager and we got together and discovered "The Animals" and in fact, their recording of "House of the Rising Sun" was my first record as an engineer. I went in there, not knowing a damn thing, and got down the track that was to make Michael a lot of money when we had parted company. However, I got posted back to London and away from all that was going on and immediately decided I had had it

with the Air Force and wanted to get out as quickly as possible. I just waited till it came time for my discharge and then went straight into music.

Essentially what happened then was that, I went through five years of being a bass player in residence at Ronny Scott's club, then went on from there to BBC because I got tired of the jazz thing and people saying, "oh, he can't read, he's a good jazzer, but he can't play anything else." I wanted to prove that a good jazzer could make a good straighter anytime. I got a job as principal bass player at BBC and during a three and a half year stint with them, got very sick; went in the hospital, had operations on both lungs and ended up being told to leave the country for a warmer climate because of trouble with my ears.

Eventually, because of my health, I went to Africa for a year, couldn't stand the politics, but did get better; realized I would have to move on and ended up coming to California. I got in touch with an American friend I knew in Los Angeles, Lloyd Morales, who is a drummer now with Bobby Benton. Lloyd was kind to me, put me up for several months and helped me find contacts with the music industry. I was working with Lainie Kazan as a bass player but I was also working at Sun West Studios as a consultant. I tried to get my green card for permanent residence status in California which proved to be absolutely impossible.

After three unsuccessful attempts to come in, with help from Senator Murphy, Pat Boone, and Lainie Kazan, none of the petitions were accepted; I was on my way back to England with my tail between my legs and stopped off in New York to do a final gig with Lainie at the Plaza Hotel. Just while I was there I happened to go down to the Record Plant and they needed somebody in the technical area and said, "yeah, we'll apply for you to come into the country as an audio/video repairman, you're obviously qualified" and then they looked at my papers and said, "why didn't you come in as that before?"

So I started to work for the Record Plant and from there I went on to Media Sounds as chief engineer. That is where I really went on to

synthesis because that was where I met Bob Margouleff and that was where Tonto was conceived."

**Bryce:** "When was that?"

**Cecil:** "Late '69."

**Bryce:** "So Moog was in existence at that time?"

**Cecil:** "Yeah, Bob Margouleff bought one of the first Moog's and was in the process of figuring out how it worked. When I came along, he was doing things with a limited amount of success because his technical expertise was very limited. Here I came along and was eating it up with all the electronic experience, it jelled. Right there. Keyboard experience, bass playing, the whole thing jelled. Bob and I decided we were better off together than we were individually because he had the equipment and I had the know-how. And so, we made a fine team and we stayed together and produced "Expanding Headband," Tonto's first album.

**Doug:** "What was your original concept of Tonto?"

**Cecil:** "Well, Tonto was the idea of an expanding band. It was going to be more than just the two of us. We were going to form an alliance with every synthesist in the country. We were going to take a tape and put a track down and send it to the next guy. He was going to put another track on it and he'd send it to the next guy, like a chain letter. The idea being to call it, "The Original New Timbral Orchestra." It was a nice non-descriptive title and we decided for short it would be called the "Head Band." It was a nice play on words and it was one of Bob's brighter name ideas.

After we produced the first album, we were doing a live performance as follow up to try and help sales. It really got to be an interesting situation because what happened was, we were running nine feet along the equipment and that got to be an exhausting situation running from one instrument to another. That was when we conceived of the idea of building new cases that were circular and building it much more ergonomically. In other words, on the back, you try to make them ergonomical from the serviceman's point of view. On the front, they should be ergonomical from the operator's point of view. That's how

CONTINUED

## MORE Malcolm

Tonto is designed. The back is perfectly servicable; from the front it's perfectly playable.

Fortunately at that time, Stevie Wonder got hold of a copy of our album through a friend of ours and Stevie came down to the studio with Ronnie Blanco on one arm and Gene Keyes on the other. He came zooming into the studio saying, "Hey man, where do I play these sounds. Who makes these sounds. Where do I get my hands on these instruments?" So we started a relationship with Stevie that went on for three years and produced "Music of my Mind," "Talking Book," "Innervisions," "Fullfillingsness First Finale," plus 245 or 250 other tracks in various stages of completion and 40 finished tracks some of which I believe are on Stevie's new album though I haven't heard it yet. It got a very good review and I've heard they've given me a credit on the cover and so I presume they used some of that material even if it was just the basic track of whatever. I haven't worked with Stevie in the past two years. However, I was very pleased that he was involved with the instrument at the time he was because it enabled Bob and I to pour every cent we earned into Tonto.

As time went by, our viewpoints changed and Bob got more and more interested in the production and engineering side. His attitude was that we should be doing more production and engineering and that's where the money is and the instrument soon won't be unique anymore and our money will go nowhere. Anyway, he has this thing that he's not a live performer and my background was performance. I was interested in live performance — which was the main reason Tonto was born — not just to record but for live performance — to be a playable instrument. A Rolls Royce among its class.

So that left me with — well, am I going to carry the whole thing on my shoulders or am I going to split the whole instrument down the middle and Bob and I take half and half? We finally decided that rather than break the instrument up I would take on the responsibility of the company's debts and give Bob his freedom to go and do whatever he

Bill Matthias



"They don't have to know too much about synthesis, just a little bit about relating what they have in mind."

wanted, and from then on, it was up to me. So I took over about \$50,000 worth of debts and attempted to complete Tonto and to complete this room because this room wasn't built then. I have been attempting to continue on with the idea of Tonto and what it stands for and I've tried to keep it up to the state of the art; I've been getting it polyphonic. My ultimate goal is to make it polyphonic and touch sensitive. There are some bugs to be ironed out of the polyphonic touch sensitive. Combining the two creates problems of its own, but now they have been thoroughly researched and are soluble. I can't say it's solved, I can't actually play it for you. However, the situation is that Tonto has to earn its own keep. Hence, I built this room with the last of the money that could have gone for the polyphonic keyboard. Tonto (the room) was acoustically designed so that it doesn't have any standing waves or resonances in the audio spectrum and it gives you a clear indication of what you're programming. One has to be able to hear clearly no matter what instrument you're playing, synthesizers especially, because nuances of the sound are everything in the end. To be able to hear subtle differences is very important. So consequently, the room is part of Tonto; you're sitting in the instrument and the instrument is not complete without its voice, so to speak.

We have a 24 machine with Dolbys; we have a 24 track board, a two track, an excellent monitor system, an Eventide digital delay and

all sorts of usual accouterments that one would have in a professional control room. So we have in this room both an instrument and professional control room equipment, the players, and that leaves you in a position of maximum advantage.

Joan Baez was here recording both sweetening and environmental tracks, waves, wind and gulls, animals for a song of hers called "Seabird" and several other tracks on her upcoming album. We've had James Taylor here doing stuff; we have Billy Preston here working on his current album with my ex-partner Bob who's acting as producer."

**Bryce:** "Where would you like to see Tonto get to?"

**Cecil:** "I'd like it to go into live performance. I'd like to see it in the concert hall with a full sized symphony orchestra opposite it, or maybe a whole rock group or both."

**Bryce:** "What kind of interfaces have you done with visuals so far?"

**Cecil:** "We've done a couple of films; bits and pieces for some features and a couple of B movies, the usual sort of stuff you get when you're on the fringe of the film business but so far I haven't had what I really like which is like "2001." I'd like to land the score but I'm competing with Leonard Bernstein and every great composer in the country; unless someone looks at Tonto and says, "Wow, I gotta have that in my movie!" They used it in "Phantom of the Paradise" and there was an agreement that they were supposed to have used it on the sound track when it was depicted

as being played in the picture, but they blatantly broke that agreement and then settled with us out of court. They had some bloody piano playing in the background; I couldn't believe it. It was a very, very hardening experience. But I believe that in the end, it will come right; that somebody will see the potential in Tonto and will see the potential in the sort of albums I've been doing. I don't even have an American contract for my albums; that's how sort of underground Tonto is. My albums are sold in the rest of the world by Polydor which is the number one company in most of Europe. So I enjoy a lot of sales outside this country, but the first album "Tonto's Expanding Headband" was on Embryo which was Herbie Mann's label; a subsidiary of Atlantic and was re-issued when we got our Grammy. Bob and I got a Grammy for engineering and for co-production on Stevie's album; besides Stevie's Grammys, we got one for the best engineering of a non-classical recording of '73 for "Innervisions." When that happened, Atlantic pulled the album out of mothballs and re-issued it with our names big and prominent on it and sold another few hundred thousand. Although it's difficult to get an accounting from these people so I've got to get that together at some point in time. There's no fortune there but there might be a buck or two. Certainly enough to finish the touch sensitive polyphonic keyboard. The other album I've done is the "Pyramid Suite" which is the story of the pyramids. There's no American deal for that; have had lot of tries to get one; nobody seems to know what the hell to do with it. So that's lying silent at the moment and I'm working on another album which is a series of thirty-six images. The images were drawn by a fellow named Fuji; they're air brushed and all mandalas of various types; most of them circular. They are being used in training ladies who are going to give birth. The child bearing exercises are practiced while these images are projected on the ceiling and the ladies are lying on their backs on the floor. When it comes time for them to have their baby, the images are projected according to the stage they're in. The idea is that even though they might be in pain, it will help to release the pain and

will turn into a pleasant experience.

**Bryce:** "Are there any people involved with synthesis currently that you have a strong respect for?"

**Cecil:** "Well, there are a number of people in the field who I have a lot of respect for. There's people like Peter Zinovieff, one of the unsung heroes in the synthesis world who's behind EMS and all their things. Most people don't realize how heavy his equipment is, they don't know how to use it. I think that Mr. Pearlman and the Arp company have done a sterling job in a lot of things. Bob Moog, I don't think he really knows who I am, or what I do but he's a man who I have the greatest respect for, along with Walter Carlos. There is Serge Tcherepnin and Armand Pascetta. Most of Tonto's equipment in the last four years has been built by Serge, Armand and myself, or some combination of us. I think Tom Oberheim did a good job as well, especially the expander module and polyphonic keyboard."

Bill Matthias

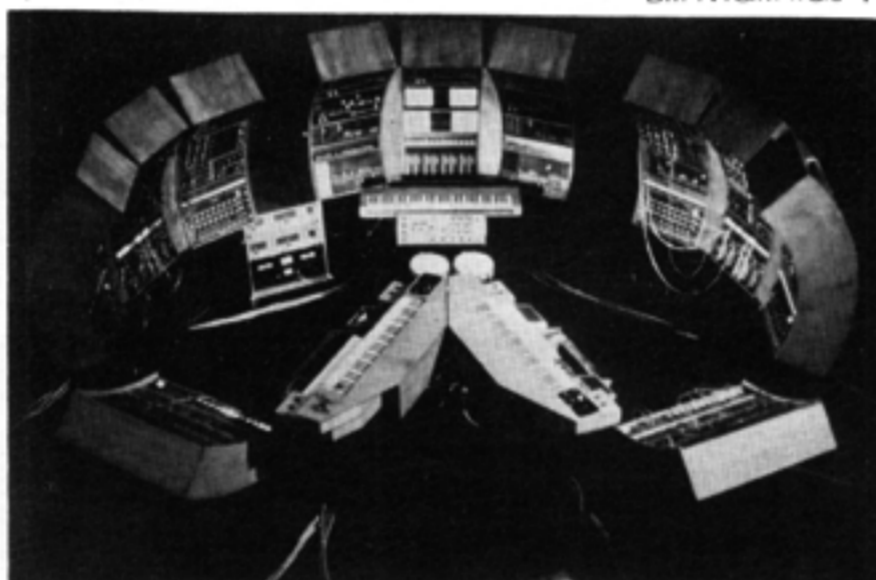

**Doug:** "What does Synthesis mean to you and how do you approach it?"

**Cecil:** "Hegel was, to my way of thinking, the first man to define the process of synthesis. I'm not talking about the dictionary definition, if you look it up in the dictionary, it will say something like: *synthesis: a fusion of elements*, OK, that's great, but it doesn't tell me the process. How do you fuse the elements? Hegel came up with the first basic principal of synthesis. He said: first one takes the process of the reality around you and looks at it and says: this is thesis, there is a theory to the way this is. We'll apply it to sound, so the thesis of sound will be the theory of sound; which is the understanding of how sound behaves. The next thing to do is to negate that thesis and the anti-

thesis of sound, is of course, silence. But, silence doesn't exist anywhere. I thought silence really existed, and I was fortunate enough to have an illicit turn in one of John Lily's little think tanks; you know, where you lie in this thing and you are the same weight as the water and you don't feel anything and are cut off from all sensory inputs, and I thought it'd be beautiful and quiet. The only trouble is, you get in there and you hear bump, bump, bump, bump and you think, "what is all that noise? Is there a pump going here?" and you realize "yes, there's a pump; it's called my heart. What is all this rushing sound? My God, it's my blood." So I began to realize that in this real world there is no silence. The only place there's silence is in the imagination, so you go from the world of thesis sound into the world of imagination where there's no sound and you negate that, you create sounds within that silence and that's synthesis. The limits of the imagination will determine how good or bad a synthesist you are. Then there's one final process which Hegel doesn't talk about. Hegel talks about the three part process: thesis, anti-thesis, and synthesis, syn-thesis. I took one other *analysis*, because by taking what you have synthesized, and analyzing it, and pairing it with reality, what you come up with is a comparison, you come up with an ability to judge how close you've come to what you've imagined in the anti-thesis."

**Bryce:** "A lot of the things that we've talked about so far are mostly involved with the people that are manufacturers or inventors. Are there any artists who's work you are particularly interested in?"

**Cecil:** "Oh yes, Tomita, he's super, sometimes his sounds are a little electronic for me, but that's OK. I like the way he gets out there and says, "Well, the hell with it. You can go whooooooo," and he does, you know, right in the middle of Debussy, ah, nothing is sacrosanct and he lets it all hang out there. I think Larry Fast is doing a good job with Synergy. I like Stevie Wonder's use of the synthesizer, especially Tonto. Billy Preston and Joan Baez, really use it well. I've found that most artists once they become familiar with what the capability is, are capable of producing incredible things,

CONTINUED ON PAGE 33

# SOUND ARTS: WEST COAST SYNTHESIZER COMMUNITY

by Luther Donaldson

The wall to wall synthesizer grouping which forms the heart of this studio community includes: Moog model 3-P and model 15, 4 voice Oberheim, Arp 2600, Minimoog, Maxikorg, and Buchla, along with professional recording studio equipment. Heading this operation is: Dan Wyman, Peter Bergren, and Bob Walter. Collectively, these three partners bring together a diverse grouping of qualifications: Wyman - co-founder of the USC Electronic Music Department, involved with film, avant-garde music, rock composing and programming, is also one of the foremost teachers of electronic music on the west coast; Bergren - an engineer, producer, and audio equipment designer, is head of the USC Recording Arts program that takes places at Sound Arts; Walter - a founding member of the Company Theater, is a writer, actor, musician, resident barbarian, and Sound Arts' project coordinator.

These three formed Sound Arts to be more than a recording studio. They have established the framework for an

audio resource center specializing in electronic music by providing studio and production services, equipment, and instruction to the entertainment community.

Related diversity is the paradox that seems to fuel Sound Arts' engines. Studio activity runs the gamut from experimental work on creating giant rock demons and tidal waves for Sanrio Films; to logos for the Presto pressure cooker; to music for "The Anderson Alamo" a film about Los Angeles street gangs; to music for a portion of the Magic Pagoda at Magic Mountain; to straight ahead rock and roll production with the kind of sweetening usually only available at much larger studios; to music for "Indonesian Boomerang", an anti-war film; to a rehearsal for the EMQ (Electronic Music Quintet) the house band.

This organizational idea is linked with Sound Arts' beginnings, which are tied into the life of the late Paul Beaver, who owned and operated the space that is now Sound Arts'.

Bergren: "We came together as partners because of Paul's death in

January of 1975. The USC Recording Arts program needed a home, and we needed to keep the studio going or let it all go past the boards."

Wyman: "In the beginning, there was a studio which belonged to Paul which was not a studio, but rather a large barn which had some good equipment in it and a lot of antique equipment also, and it needed a tremendous amount of organization. Paul didn't concentrate on the use of his barn as a studio but rather as a receptacle for old instruments, new instruments, and at one time his bed and bathtub too, (which remained somewhat hidden from the studio). He was an interesting combination of what seemed to be great flexibility and yet at the same time, great personal discipline. What he did as a synthesist and as a musician, he did exceptionally well. Without a doubt, he was a very special person to us, and he guided what is now Sound Arts, long before it had that name."

Walter: "When we began this enterprise, many hours were spent discussing organization, but somehow we never came to a codified, collective philosophy. It seemed vital to determine what each one of us wanted so that we could see a set of goals and a working environment that permitted maximum flexibility. I think that a philosophy can trap you by defining a space which you are then committed to staying within - even when that space becomes too restricting. Some of our goals like: providing products and services that are affordable, or fostering a feeling of freedom in order to allow a greater sense of experimentation to creep into the hard and fast world of the commercial market, have caused this experiment in creative democracy to evolve into an operation that appears to have a philosophy.

There is a theme that runs through what we are doing now and what we hope to be doing and that is, the "creative use of sound." Synthesizers are not the end all be all. They are a tool, they are very important in that way, but standard instruments - acoustic instruments of our own construction, tape collage, sound effects and voices used in a wide variety of ways make up the basic tools."

Bergren: "I think "creative use of sound" is a bit nebulous a phrase. The heart of our work is the orchestration of elements not usually considered to be musical sources in the traditional



Jon Christie

The EMQ - clockwise from lower left: Dan Wyman, Darrell Sausser, Gary Takesian, Dave Johnson - the Advanced Electronic Music Workshop that refused to disband.





Bill Matthias

"Above all, there is a feeling around the studio of commitment to electronic music and to the creation of a positive environment." Left to right: Jane Bergman, Dan Wyman, Jim Cypherd, Bob Walter.

way. We are trying to take this Musique Concrete (in which synthesis is only a part of) out of the confines of being a laboratory curiosity used by a small slice of the artistic community, and we are slowly proving that it is a viable style that can be used to produce things which are exciting to large groups of people and have application in the day to day commercial world - be it in a pressure cooker commercial, a film score, or a pop record. I'm not talking about just adding a synthesizer line as an instrumental line, or as a specialized bass sound, or for fattening up brass, I'm talking about inventing one sound out of another, that subtle little twist you give things that puts them into another dimension."

Walter: "One important idea we try to keep central is never to become too insular. We want to keep aware of what other people are doing, and to create a working situation that will allow us to link up with a maximum number of those who are doing exciting things. We want to provide a meeting ground where because of

what we have set up, individuals who share similar creative goals can come in contact with each other."

Bergren: "We advise many schools in helping them to set up or expand their electronic music facilities. We try to connect people who have instruments to buy or sell to possible resources that will allow them to complete their transactions. We sell Moog systems, and in an almost custom designed situation like this, Dan spends a lot of time advising, but, we are not a "hang out" place, and the free advice that is dispensed is for those who are committed to doing something with it."

Walter: "If that sounds harsh in any way, remember that for Paul this place was a toy, a giant train set. We have had to organize the flow, because the amount of activity has probably increased tenfold since the "old" days. A stranger to our midst who wants to involve himself with us receives no promises from us other than that we will deliver a workshop which guarantees access to a large body of equipment and a good teacher. This

situation has an inherent quality to it. No one is here hat-in-hand waiting for favors to be bestowed; and thus when someone does emerge from this situation, it happens naturally out of a positive, mutual energy flow.

Jim Cypherd, an extremely talented musician, engineer, synthesist, and designer, was a former student of Dan's and Peter's, and now is the fourth member of Sound Arts. The EMQ (David Johnson, Leonard Sasso, Darrell Sausser, Gary Takesian, and Dan Wyman) was originally the Advanced Electronic Music workshop that refused to disband, stayed together doing projects, went through some personnel changes, and is now being received very well as they begin performing publicly, with a repertoire of everything from Bach, Jelly Roll Morton, Rock, and new music. The majority of the group is made up of studio musicians/music teachers who honed their electronic music skills in our workshop."

Attending one of Dan Wyman's Electronic Music Workshops, and

CONTINUED ON PAGE 34

# ILLUSION & MOTION

## YOU CAN'T BELIEVE EVERYTHING YOU HEAR

by Alex Cima

When you listen to your stereo speakers this listening condition is said to be a "free sound field" since both ears receive the information from both speakers in a reverberant room. If you listen through headphones, it is then possible to select and restrict the information going in each ear; for example, if you patch a voltage controlled oscillator (VCO) into the left speaker and a second VCO into the right speaker, both will be heard by both ears in a free sound field, but, if equally panned and heard through headphones, that is, VCO 1 to the left ears and VCO 2 to the right ear, then only the left ear receives VCO 1 and only right right ear receives VCO 2. This type of listening is called "dichotic." (Be sure that the headphones have good channel separation and that the sound level is not so high as to induce bone conduction leakage to the opposite side.)

Dichotic listening is a technique used by neuropsychologists, audiologists, and others interested in neurological and speech research; its musical interest lies in the fact that some auditory experiences available through dichotic exposure are unique and not possible in a free sound field. This technique may lead some day to concerts in which the audience wear headphones (or other similar technology) and pieces are written for "dichotic environment."

### Patch 1: Dichotic tuning of 2 VCO's

For this patch you will need 2 VCO's (same waveform, preferably sawtooth), and 2 voltage controlled amplifiers (VCA's) as follows:

For the sake of comparison, it would be nice to be able to switch from one condition to the other (dichotic/free sound field), perhaps accomplished by either:

- 1) stereo/mono switch in your amp.
- 2) if going through a mixer, panning to the respective side or to center.
- 3) take off headphones and listen through speakers (speakers and headphones should not be on at the same time).

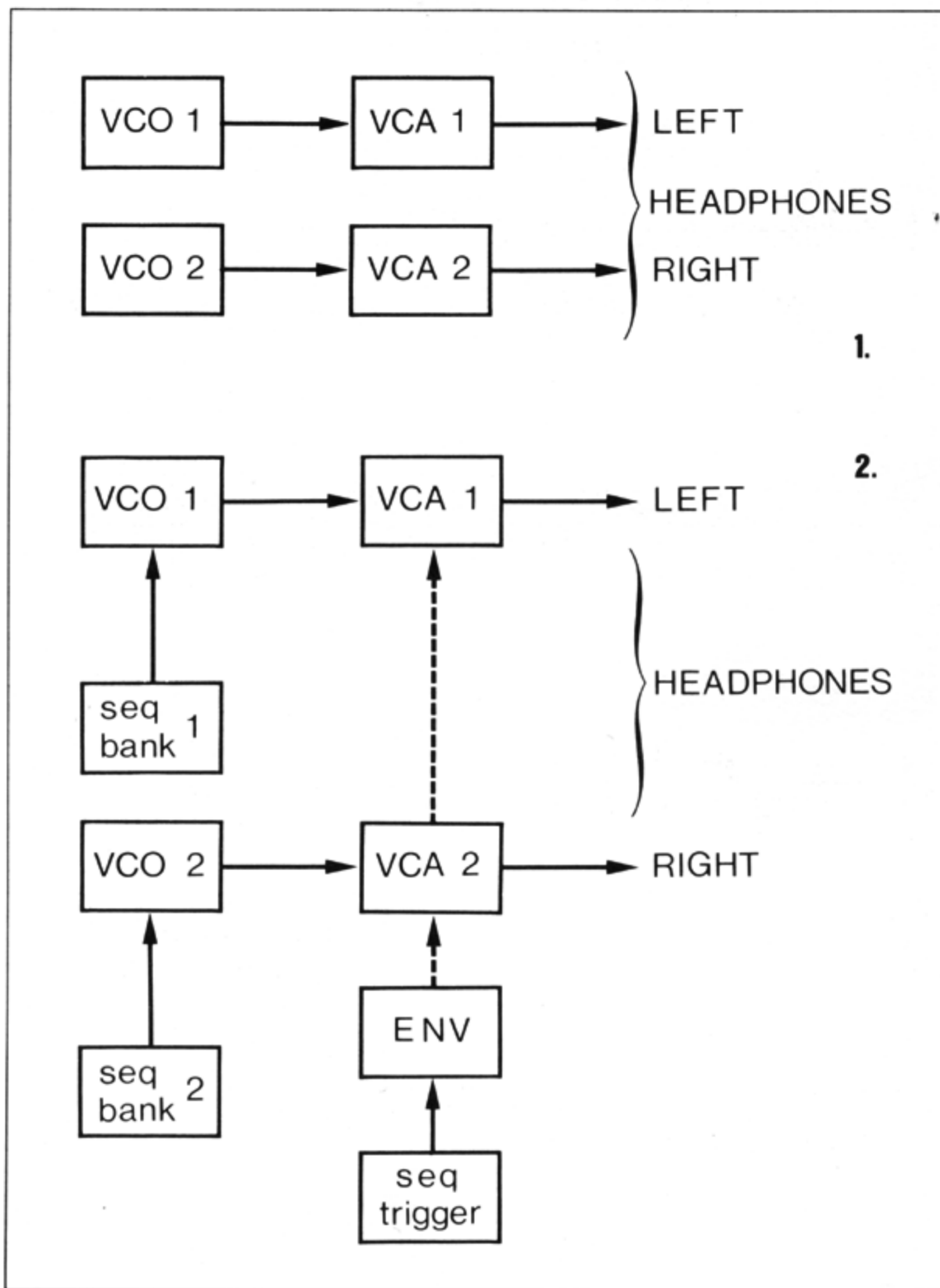

First, begin with the dichotic condition and tune 2 VCO's in unison, since the effect you are about to hear is frequency dependent, the VCO's should be tuned in the low range, try different ranges for comparison. Once you think they are properly tuned in unison switch to the free field condition and you should hear beats not audible in the dichotic condition. While in the free field condition, tune the VCO's so that they beat at a rate of 1 or 2 hertz, now switch to a dichotic

condition and you should notice that the beats are present as a sensation of "location modulation", that is, motion from right to left or vice-versa, depending on which VCO is tuned highest. If you slowly change the beat frequency of the other VCO from flat, through unison, to sharp, you will notice the sound "image" moving from ear to ear right through the middle of your head. In unison, the sound image appears in the center of the head and is said to be "fused".



LEFT EAR



RIGHT EAR



6.



RIGHT EAR PERCEPT

FOR MOST RIGHT-HANDED SUBJECTS



LEFT EAR PERCEPT

Sue Denim

**Patch 2: Sequence illusion**

The following illusion has been investigated by Diana Deutsch, from the University of California, San Diego.<sup>1, 2</sup>

For this patch you will need an analog sequencer (SEQ) (minimum of 2 banks of 8 steps each), 2 VCO's, 2 VCA's, and 1 envelope generator (ENV) (with two outputs, one to each VCA) triggered from the sequencer clock. The following is an analog patch of the digitally generated sequence given by Dr. Deutsch in her experiments:

Note: use a staccato envelope (fast attack, short decay) and a clock rate of 250 milliseconds per step (4 steps/second).

The frequency of VCO is controlled by the first bank of the sequencer, each pot representing a pitch as shown in figure 3. VCO 1 is gated through VCA 1 to the left ear.

The frequency of VCO 2 is controlled by the second bank of the sequencer, each pot representing a pitch as shown in figure 4. VCO 2 is gated through VCA to the right ear.

The assembled intervals and the corresponding ear receiving the component pitches are as follows: (figure 5)

Notice that every pitch is a member of an ascending or descending C scale alternating ears. Among other things, Dr. Deutsch found that most right-handed subjects will hear a high pitched melody in the right ear, and a low pitched melody in the left ear (see figure 6). Left-handed subjects are not as likely to demonstrate this "laterality" effect.

The implications of her research apply to concepts regarding cerebral hemispheric dominance.<sup>3</sup> Other auditory phenomena involving dichotic presentation require more hardware (a digital computer), and an appreciation for the neurological literature on the subject of dichotic perception.<sup>4 5 6</sup> However, many dichotic patches are possible using only analog equipment; the musical implications are yet to be explored by composers. 

**Footnotes**

- <sup>1</sup> Deutsch, Diana. "Two Channel Listening to Musical Scales." *Journal of the Acoustical Society of America*, 57:5, 1156-1160, 1975a (May).
- <sup>2</sup> Deutsch, Diana. "Musical Illusions." *Scientific American*, 233:4, 92-104, 1975B (October).
- <sup>3</sup> Cima, Alex. "In Search of the Musical Hemisphere." *Synapse*, 1:1, 14-16, 1976.
- <sup>4</sup> Kubovy, M., Cutting, J.E., and McGuire, R.M. "Hearing with the Third Ear: Dichotic Perception of a Melody Without Monaural Familiarity Cues." *Science*, 186, 272-274, 1974 (18 OCT).
- <sup>5</sup> van den Brink, G., Sinnicolaas, K., and van Stam, W.S. "Dichotic Pitch Fusion." *Journal of the Acoustical Society of America*, 59:6, 1471-1476, 1976 (June).
- <sup>6</sup> Bogen, J.E. "The other side of the Brain. II: An Appositional Mind." *Bulletin of the Los Angeles Neurological Societies*, 34, 135-162, 1969.

The author suggests reading the Scientific American article first if more information is desired.

# A BIG SYNTHESIZER'S LITTLE HELPERS

## MANUAL CONTROLLERS, PRESETS & PRESTO PATCHES

by Arpad Benares

Just as there are small and big airplanes jetting around in the universe, there are small (and very common) synthesizers and large (much rarer) synthesizers. With few exceptions, the smaller synthesizers are keyboard types which are basically designed to do one task well: play melody and do a limited number of synthesizer effects which have become commonplace on pop music wavelengths. The larger synthesizers, however, have a much wider and subtler range of expression involving many more effects, being capable of *flying* at much higher altitudes than the smaller machines. Typically, the larger synthesizers are studio-type machines featuring modularity, open-ended patch-ability, and increased sophistication of functions. Modularity means that a studio synthesizer can be expanded to include as many modules as a musician may want - 10 filters - if that's what he needs. Open-ended patchability, on the other hand, means that the modules within a system can be interconnected in an almost endless variety of ways. This is in sharp contrast with pre-patched keyboard synthesizers which offer only a limited number of interconnections, yielding therefore a much more limited palette of effects.

This being said, I don't mean to knock small keyboard-type synthesizers; just as it would be odd indeed to knock a Piper Cub out of the sky for not flying high enough. Indeed, the keyboard synthesizer, as it has evolved, is an incredible and bona fide instrument in its own right. I do mean to underline one major difference between the two types: the fully modular studio system is much harder to play, physically speaking. Just consider these facts: a typical modular studio synthesizer may have as many

as fifty separate modules, over a hundred knobs, over three hundred jacks, matrix pins, cherry switches or what have you. Playing that many controls with only two hands might seem a nearly impossible task; were it not for musicians such as Subotnick, Tomita, Carlos, LEM, TONTO, Tcherepnin, TO, CELLAR-M, etc. who have amply proved otherwise.

How do they do it? Unless I am misinformed, and they have the assistance of extra help (after all, a big plane requires two pilots, a navigator and a radio operator.) they rely upon what might be called a big synthesizer's little helpers: modules invented by canny designers to make performance on big synthesizers easier.

The modules fall under three often intermingled categories: Manual Controllers, Presets, and Presto-patch systems.

What are manual controllers? The essence of a good manual controller is that it allows a musician to have real-time control over more than just one effect, using one hand only. The joystick is an excellent example, since it has up to three independently variable dimensions that can be moved: up, sideways, and in a twisting motion. Pedals and pressure sensing knee pads also fall in the category of manual controllers, since they leave the hands free for other mischief.

One of the earliest manual controllers to be developed; and still one of the most versatile, is the touch keyboard pioneered by Don Buchla. This device consists of flat finger pads arranged in the form of a keyboard which, unlike piano-style keys, are electronic and not mechanical in their mode of operation. The finger pads work on a capacitance principle which provides control voltage outputs proportional to finger contact. Such a keyboard is extremely fast to play. Though

this was not, I believe, a feature offered on early Buchla models, it can provide up to five independently variable voltages (plus triggers) using the fingers of one hand.

So much for manual controllers . . . What about presets? There is a variety of modules which perform the function of presets; albeit in different ways and with varying capacities. A good example of such a module is the *Programmer* module manufactured by *Serge Modular Music*. This module consists of a matrix of twelve potentiometers arranged in three rows and four stages. Only one stage can be "on" at a time. Turning it "on" may be done manually via a stage's push-button, and/or automatically via its pulse input. Which ever stage is "on" produces a pulse which stays high until the stage is turned "off" and enables the voltage levels pre-set at its three potentiometers to appear at the outputs common to the three rows. Several Programmers can be stacked vertically, so that 6, 9, 12, or more voltages can be accessed at the push of a button, and/or stacked horizontally effectively creating a keyboard which can have 8, 12, 16, or more stages. The most essential feature of the Programmers (and most presets in general) is that it permits a musician to change the settings of several different potentiometers at the push of a button; thereby making it possible for him to unleash instant, potentially quite dramatic changes in the music he is performing.

*Sequencers* (memory or manual) are other commonly available modules providing presets. Most of them are constrained as their name implies, to go from stage to stage sequentially. This can be somewhat of a disadvantage if one wishes to access a stage out of sequence ("random access").

The horizon for presets is only now broadening. Computer technology and the availability of economical random access memories make it possible to construct modules essentially like the Programmer, but without the limiting factors of cost and space for the potentiometers which would no longer be needed. Such modules which no doubt will soon become available, should permit a musician to record thousands of

presets, in various groupings ("rows"), either manually, permutatively, or sequentially accessed, and effectively thousand different sounds in real time. Wait and see; just around the corner is one of the most promising and exciting new heights scaled yet in the field of high altitude music making.

*Presto-Patches* — I have taken the term from the *Putney Synthesizer* which has a function of that name. The *Putney Presto-Patch* is a mechanical means to patch any of the various modules of the *Putney* in one fell swoop, without having to patch a whole slew of patchcords one at a time. Several similar systems involving patch-pins and p.c. board plug-ins have been commercially available for quite some time. Ideally however, presto-patches should, like presets, allow a musician to go from one patch to another automatically, or at the push of a button. Available mechanical presto-patches do not allow this, since changing a patch with these systems takes time (exchanging plug-ins). This ideal has been achieved in sophisticated, and alas, very expensive computer based systems, such as Don Buchla's and Peter Zinovieff's. (These systems, it should be mentioned, do offer random access presets as described previously).

There is however, a stretch to go until the hardware for such patching systems becomes economical enough for the personal studio. Meanwhile, there are several devices now available which perform the function of presto-patches in a limited manner. Multi-pole multiple-throw relays or switches are suitable. The *Serge System*, *Triple Bi-Directional Router* is another example of a module that does the job of switching between patches.

So here you have them, a big synthesizer's little helpers. The next issue of *Synapse* will contain an article concerning assembling modules that work as *presets* and *presto-patches* specifically, the *Programmer* and the *Triple Bi-Directional Router* as discussed previously.

Please let me know c/o *Synapse* what you think of all this. I am especially interested in hearing from anyone now experimenting in the wide open space of computer, or micro-computer data-handling of presets. 



## SYNARE

\*percussion synthesizer

The beat goes beyond. The world of electronic percussion is yours with the Synare P.S.™ . . . the first fully integrated percussion synthesizer.

Put thunder, lazy days, chimes, brake drums, gongs, jackhammers, rain, rush hour . . . under your sticks. Designed for use with or without a drum set, the Synare P.S. is played with sticks like a drum, has bounce, and requires only a conventional sound system.

P.S. Write for information about the Synare P.S., the first fully integrated percussion synthesizer, and the dealer nearest you.

Suggested retail \$695.00



**STAR INSTRUMENTS INC.**

Dept. S, Box 71, Stafford Springs, Ct. 06076 tel.(203) 684-4421



**Ultra stable oscillator with foot selectable preset frequencies • automatic squelch inputs for optional pressure sensors (pedals) controlling the amount of modulation (0-100%) and/or glisses of the modulating frequency • long 9v. battery life.**

**Cost: \$150.00 C.O.D. only, Calif. residents please add sales tax. Pressure Sensors are \$32.00 each.**

**SYNERGY ASSOCIATES**  
**1107½ N. Western Ave.**  
**Hollywood, Calif. 90029**

# EQUIPMENT REVIEW

*Polyphonic systems are suddenly the hottest new trend in synthesizer design. Three new instruments, embodying different approaches taken by the leading manufacturers are examined this month.*

## Oberheim Polyphonic Synthesizer Programmer (PSP-1)

It can honestly be said that this is the most revolutionary new instrument on the market. The PSP-1 is offered as an accessory to the already available Oberheim Polyphonic Synthesizer; that instrument featured four or eight of the well known Oberheim Expander Modules interfaced together with some master controls and a keyboard to create a four or eight voiced system. The PSP-1 introduces a further interface - that of a digital memory, which allows the performer to program his own patches and recall them from the memory instantaneously at the touch of a switch. (If you don't already own an Oberheim Polyphonic Synthesizer, you can buy one with the PSP-1, already installed of course.)

This may all sound technically formidable but the programming is actually quite easy to do and requires no knowledge of digital hocus pocus. The programmable parameters include oscillator frequency, VC Filter center frequency, and modulation (but not "Q" unfortunately), vibretto, and attack-sustain-decay characteristics on the separate VCA and VCF envelope generators. The memory can contain up to sixteen patch programs. In the near future Oberheim plans to offer a device that will allow the performer to store an essentially unlimited number of patches on ordinary cassette tapes.

Another very attractive feature of the Polyphonic Synthesizer itself is the fact that it employs two

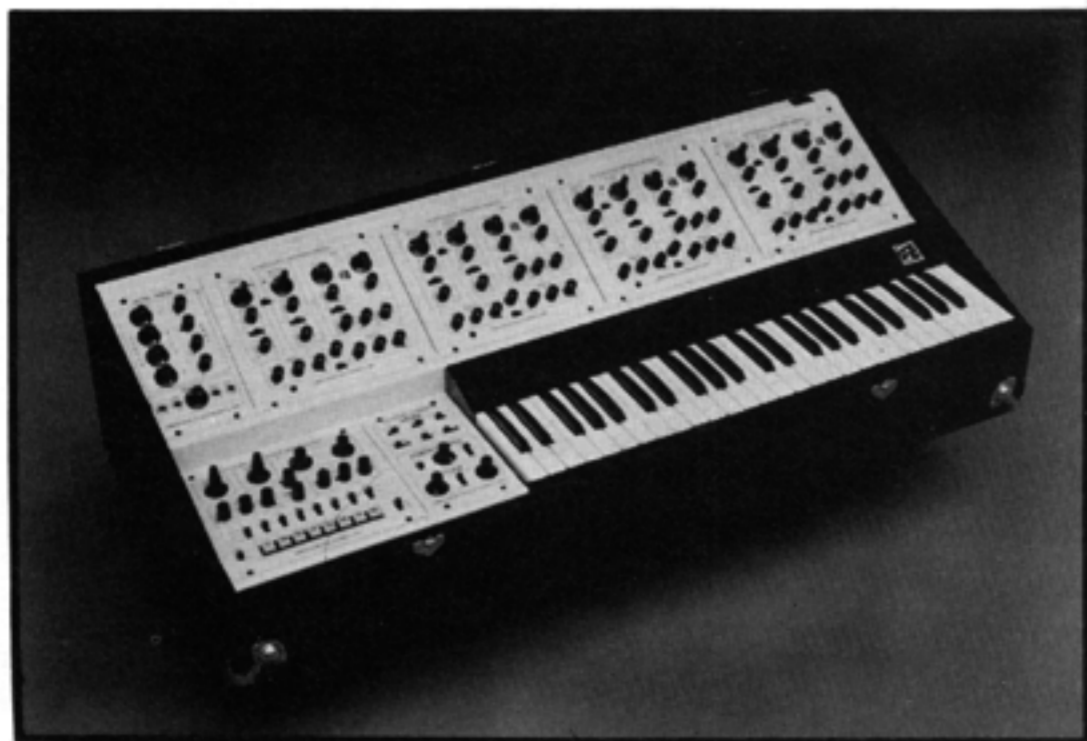

The Oberheim Four Voice Polyphonic Synthesizer with the PSP-1. The most revolutionary new instrument on the market?

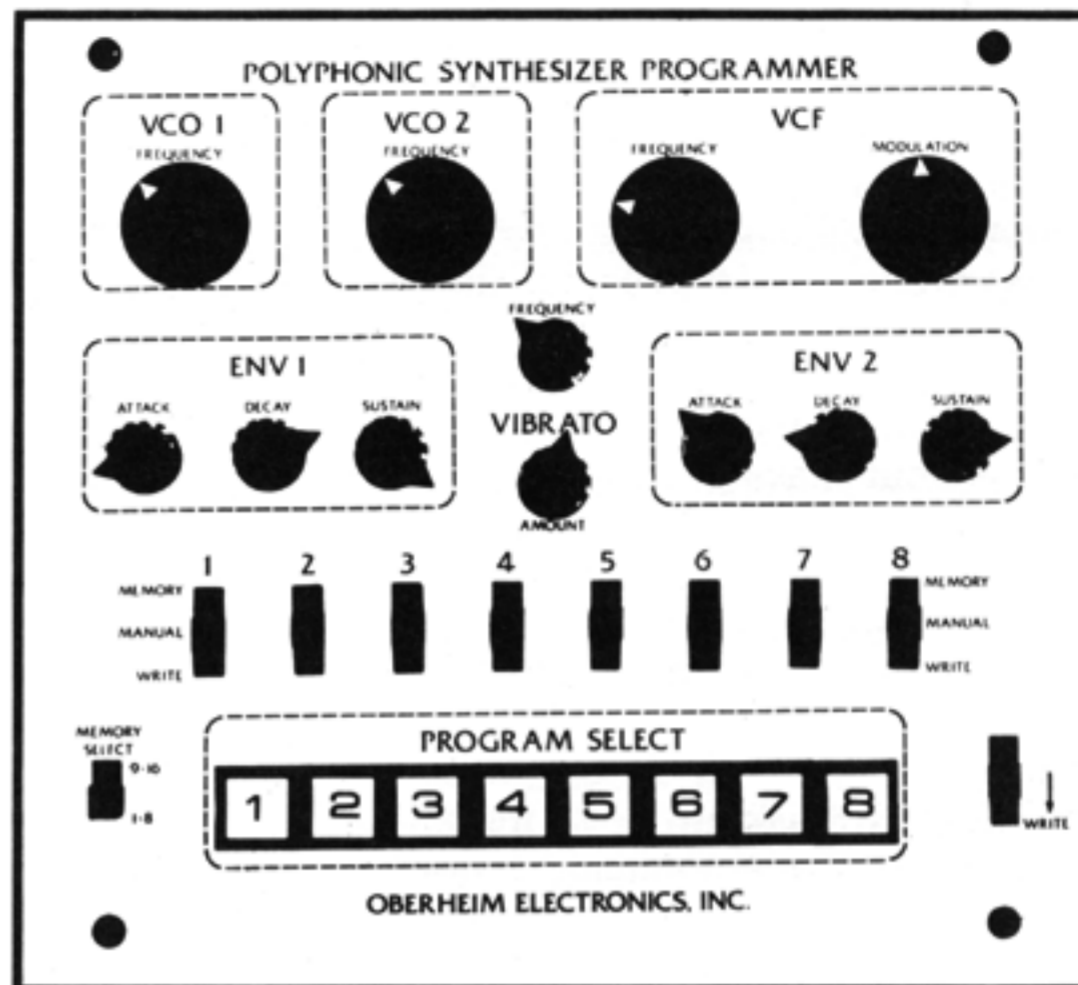

The Oberheim Polyphonic Synthesizer Programmer (PSP-1). Sixteen programs can be stored and recalled at the touch of a button.

oscillators, two envelope generators, a variable-mode filter, a VCA, etc., for each voice. This results in an unparalleled richness and "fatness" of sound that is truly breathtaking to hear.

For all this magnificent technology, however, an equally magnificent price must be paid. The PSP-1 by itself retails for \$1395. A programmable four-voice system costs \$5390; an eight-voice is \$9785.

## Polymoog

A different approach to the polyphonic situation is taken by this new instrument from Moog. Unlike the Oberheim, the Polymoog is fully polyphonic. Each one of its seventy-one keys will produce its own tone, simultaneously if desired, just like any piano or organ. Moog spent \$100,000 developing a single IC (integrated circuit, or "chip") that would perform the functions of two envelope generators, a VCA and a VC Filter. With one these chips directly triggered by each key, it became possible to have individual gating and filter sweeping throughout the range of the keyboard.

The only drawback to this plan is that each key does *not* have its own oscillator. The actual waveforms are generated by the electric organ trick of top-octave division. The Polymoog, therefore, does not possess the vivid "fat" sound of the Oberheim or even Moog's own monophonic Minimoog, where a single tone is created by more than one oscillator.

The Polymoog does have many other interesting

features. Lighted switches and digital readouts help keep track of what's going on on the large control panel. The nearly six-octave keyboard is the largest synthesizer on the market. Also, the keyboard is touch sensitive; like a piano - the harder one plays, the louder the sound. There are controls for formant/equalization-type filtering, as well as the usual VC Filter, while foot-pedal accessories can do some of the work the hands are too busy for. Moog's Ribbon Controller is still the preferred method for pitch bending.

In addition, there are buttons for nine pre-set patches. They include such instrumental timbres as strings, piano, brass, clavinet, etc., as well as a variable pre-set programmable by the performer.

Two years in the making, the Polymoog is obviously a well thought-out and finely crafted instrument. However, for a machine of its size and price, it is disappointing that it does not include such features as ring and frequency modulation, more control voltage options and external patchability. In LA the Polymoog retails for a stiff \$4500.



The Polymoog's keyboard is touch sensitive and reaches nearly six octaves. Moog spent \$100,000 developing a single IC that would perform the functions of two envelope generators, a VCA and a VC filter.

## ARP Omni

The Omni employs the most modest approach to polyphonics and also has a modest price: \$2395.

It is essentially two instruments played from one keyboard. The one half of the Omni is a string synthesizer possessing truly remarkable, lush sound. Undoubtedly, the Omni will soon replace ARP's own more ready-sounding String Ensemble.

The other half is the synthesizer itself, the part subject to timbre variation. As in the polymoog, all

frequencies are generated by top-octave division, so the sound is a little thin. Another weak point is the single trigger for all keys; notes can not be individually gated or filter swept. But what do you want for \$2395? There are some distinct touches, such as a foot pedal that controls envelope decay time, and a slider pot that mixes together the string and synthesizer timbres for some interesting effects. The Omni definitely can fill the "polyphonic need" of the budget minded synthesist.

- Tom Davey

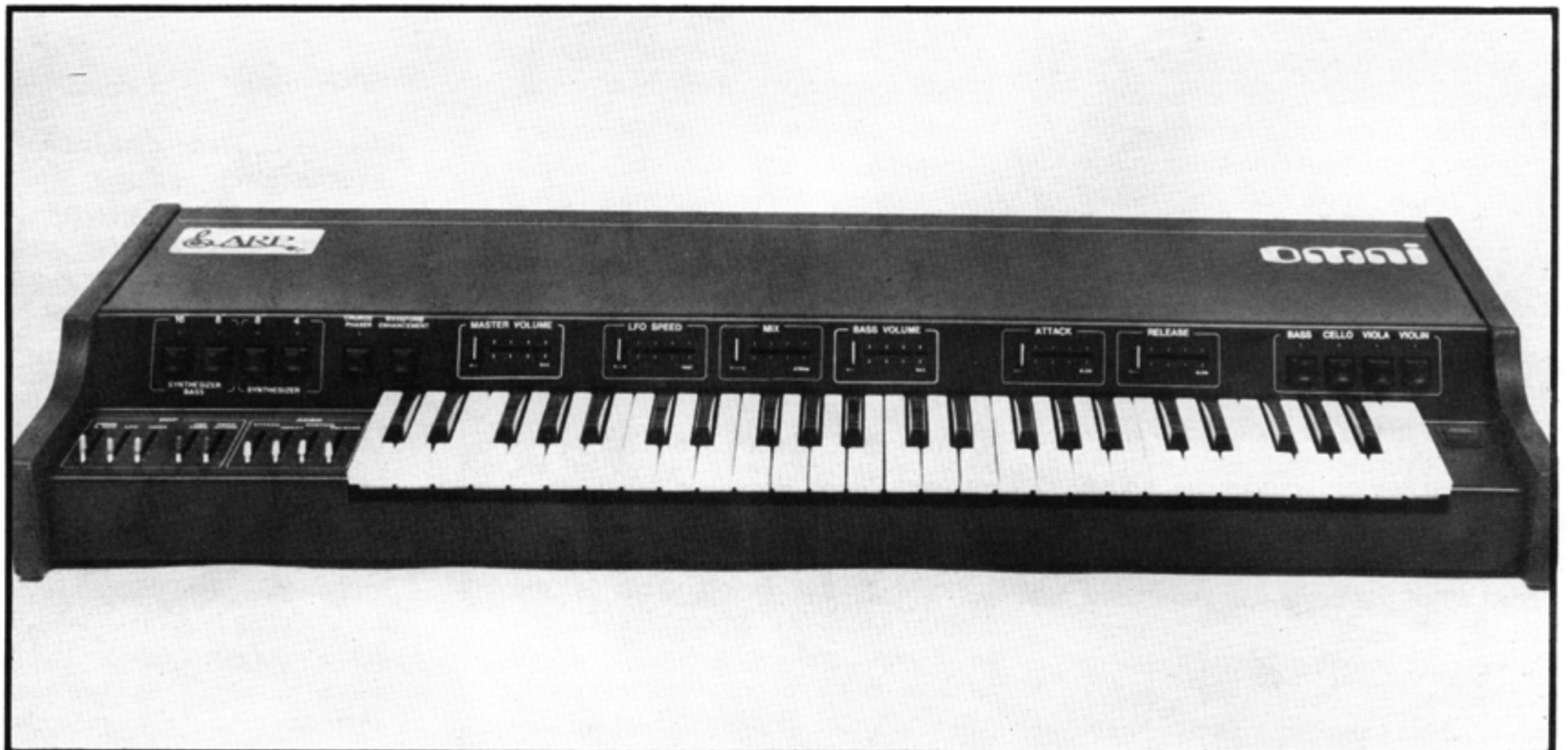

The ARP Omni - a modest approach to polyphonics. One-half of the Omni is a string synthesizer possessing a remarkable, lush sound, the other half is the synthesizer itself - the part subject to timbral variation.

# DISCREVIEWREVIEWREVIEWREVIEW

**Beyond the Sun: An Electronic Portrait of Holst's The Planets**  
Patrick Gleeson, Eu Polyphonic Synthesizer.

**Side One: Mars, the Bringer of War; Venus, the Bringer of Peace; Mercury, the Winged Messenger; Jupiter, the Bringer of Jollity.**

**Side Two: Saturn, the Bringer of Old Age; Uranus, the Magician; Neptune, the Mystic.**

**Mercury SRI-80000**

There's more to this one than meets the ear. *The Planets*, composed between 1914-1917 by Gustav Holst, is a suite of many textures and colors. It ranges from the earth-shaking, to gentle pastels, to feelings of great distance; from a single french horn to 100 piece orchestra complete with organ and a battery of percussion.

So it's quite a venture that Patrick Gleeson has undertaken in realizing this piece on an Eu modular synthesizer; a direct descendent of the Moog model III designed ten years ago.

Comparisons of *The Planets* with the interpretations of Bach and other Baroque and Renaissance composers by Walter Carlos are inevitable. Carlos working with the Moog; using various pedals and devices to control other parameters of the different voices; recording on an 8 track. Baroque music is much simpler than most of the music composed in the twentieth century, being distinguished by four or more independent parts, each a melodic voice, changing instruments perhaps, but going on and on to the end with few textural changes, no changes in meter or tempo, no crescendos or decrescendos, etc.

*The Planets* changes meter, tempo, orchestration, and texture, from one moment to the next. To record all of the parts, Gleeson used a Scully 16 track and MCI 24 track with dbx noise reduction to be able to accumulate as many as 80 tracks with no noticeable tape noise. However, the biggest difference between Carlos' and Gleeson's approach, is in

the use of digital memories to store pitch, rhythm, and other information for each part, rather than playing each part manually on the keyboard. A detailed description of the process used by Gleeson may be found in the preprint of his paper given at the 54th Audio Engineering Society Convention in Los Angeles last May \*

Gleeson's realization of the piece is successful, particularly *Saturn* and *Neptune*; the brass instruments especially the horns, are marvelous, as is the percussion and the wordless women's choir at the end. To me, his work is best in the slow, delicate sections. While the loud and powerful sections are good too, they aren't as earth-shaking as they could be. His strings, which he has devoted a great deal of attention to, using 15 or so tracks to create a thick sound, still end up sounding like an organ or a String Ensemble, particularly the violas. The tempos that Gleeson has chosen are generally a bit fast for my taste, but seldom does his performance sound as mechanical as his technique might imply.

This album is important musically because of its successful use of a process which is going to become more and more a part of electronic music. Now, if they could only do something about that album cover ...

\*Available from the Audio Engineering Society, Room 449, 60 East 42nd St., New York 10017. Pre-print No. 1133 D-5.

- Danny Sofer

**Morton Subotnick**

***Until Spring***

**Columbia/Odyssey Y 34158**

*Until Spring* describes the point of emergence of the butterfly from the cocoon; the thrusting out, the becoming, the being. This is the fourth work of Subotnick's *Butterfly* series, and it retains the same timbres as his recent electronic work, all done on Buchla's Series 200 Electric Music Box.

There seems to be a greater

reliance upon bursts of events here. The large majority of sounds are sequences of modulated sounds that grow higher or lower in pitch, have shorter intervals between points in the event sequence, and spatial movement. All of the points in the events are very short, sounding like knocks on wood; plucked strings or rubber bands; and bouncing balls.

Subotnick employs a system of recording control voltages that contain the information for envelope control as well as frequency and location of each point in a particular event without recording the event itself. This way, the composer can vary other parameters, (i.e. wave-shape, filtration, modulation, and frequency range) before committing the event to tape; to me, a fascinating concept.

Musically however, the "blowing-up" of one point in time to 30 minutes is ultimately unsatisfying because of the seeming lack of progression from beginning to end. Subotnick might have used a wider variety of material in constructing *Until Spring* and thereby sustained interest for a greater period of time as he did in *Four Butterflies*.

- Danny Sofer

**Patrick Moraz**

*i*

**Side One: Descent; Incantation-Procession; Dancing Now; Impressions (The Dream); Like a Child in Disguise; Rise and Fall; Symphony in the Space.**

**Side Two: Impact; Warmer Hands; The Storm; Cachaca (Baiao); Intermezzo, Indoors; Best Years of Our Lives.**

**Atlantic SD 18175**

This is an album that was released last spring but deserves mention here because of the short shrift it received from generally bewildered reviewers. Patrick Moraz is a classically trained French keyboard player who was chosen by YES to replace Rick Wakeman after Wakeman left the group to pursue obscurity. Moraz's outstanding job on "Relayer" allayed



fears that Wakeman's departure would destroy the group. Shortly thereafter, in Brazil and Geneva, Moraz recorded his first solo album, *i*.

It is a mostly instrumental, multi-movement concept album in the English rock tradition. Moraz plays a staggering number of electronic and acoustic keyboards, including the Orchestron, with its laser encoded discs, and the Polymoog, a pre-production prototype lent to him for some trial runs. Both instruments appeared in their recording debut.

Moraz has tremendous keyboard technique; particularly dazzling is a section called the *Imps Dance* where an Arp in the right channel duels furiously with a Minimoog in the left over a ferocious rock background. Excellent backup musicians handle the vocals, guitar, and percussion parts, including a native Brazilian fifteen person percussion unit whose hypnotic rhythmic complexes give much of *i* a decided Latin flavor.

And as good as all this is, the best part of the album is its rich panoply of electronic, tape and studio effects. Much of the music is wholly electronic in concept and all of it is brilliant in realization. A recommended disc.

- Tom Davey

**Herbie Hancock**

**Secrets**

**Side One: Doin' It; People Mover; Cantaloupe Island.**

**Side Two: Spider; Gentle Thoughts; Swamp Rats; Sansho Shima.**

**Columbia PC 34280**

Hancock's latest disc is less single-mindedly funk oriented than his last, *Man-child*. *Secrets* is more concerned with making the best music possible than with capturing the crossover audience. Its greater range of moods extends from the abrupt dramatics of the *Spider* cut, to the gutsy synthesizer solo of *Cantaloupe Island*, to the ethereal suspension of *People Mover*. Hancock performs on his usual large battery of electronic keyboards including the new Oberheim polyphonic synthesizer. Wah Wah Watson, distin-

guishing himself again in his writing and performing in association with Hancock, has a variety of electronic devices he uses to process his guitar, even managing to employ the "framptonized" voice bag in a tasteful manner.

The disc's only disappointment is in the timid underutilization of the Oberheim 4-voice. Otherwise, the studio work is masterful, with some clever dubbing and ambience tricks and a mix that puts the rhythm section way out in front. *Secrets* is Herbie Hancock's most mature album to date.

- Tom Davey

**Gina Vanelli**

**The Gist of the Gemini**

**Side One: Love of my Life; Ugly Man; A New Fix for '76; Omens of Love; Fly into this Night**

**Side Two: War Suite:**

**Prelude to the War; The Battle Cry; To the War; Carnal Question; After the Battle; To the War (reflection); Summers of my Life.**

**A & M Records SP 4596**

Vanelli is a singer songwriter with three previous albums produced by Herb Alpert. He writes easy listening tunes and orchestral/choral extravaganzas with titles like, *Prelude to the War Suite*. Despite some eclectic touches - momentary snatches of rock or funk - obviously designed to make him more attractive to the wider pop audience, his music remains firmly MOR with a vocal style that never varies from that of nightclubs or Las Vegas showrooms.

Vanelli's main gimmicks are the synthesizer arrangements integral to every song. This is indeed unusual for his stylistic milieu which has been slow to pick up on electronics. It could be said that Vanelli has invented "progressive easy listening." The synthesizer arrangements are flashy and slick, but considering the musical context, it comes out plain cheap.

Another interesting point is about the hilarious "relevance" of his lyrics. They have a bluntness of expression

that is quite different from the usual banal cliches of this style. One song called *Carnal Question* has a newly returned war veteran lamenting to his lady love that they can no longer get it on because of a castrating injury he suffered. The insipid music of *Carnal Question* contrasted to its grotesque subject matter is representative of the album as a whole. If you know what's good for you, you'll stay away from this turkey.

- Tom Davey

**Tangerine Dream**

**Richochet**

**Edgar Froese, Chris Franke, and Peter Bauman**

**Side One: Part One**

**Side Two: Part Two**

**Virgin V 2044**

*Richochet* is one of those albums that defies review. It's too lukewarm to be called a really good album, and yet, one unfamiliar with Tangerine Dream's body of work would find a lot on it to listen to.

It's a live album, though this means nothing in particular; except for the applause at the beginning, it all sounds studio made. It's a mish mash of other people's styles - the electronic percussion of Kraftwerk; the nebulous tape effects of old Pink Floyd; the slow, unwinding progressions of Sensations Fix - all neatly compartmentalized and catalogued.

Portions of it are very pretty. The eerie worm-like space rock on Side one builds out of a simple, steady, bottom into the kind of March Into Valhalla anthem, reminiscent of Sensations Fix and Agitation Free. The pastoral flute and piano passage that opens side two reaches breathtaking intricacy. The falling, glittering, electronic rhythms it goes into are nice for about four minutes before it begins to get very riffy.

Parts of the album begin to sound suspiciously familiar; they use the same formula, the same mix of instruments and textures, the same pace, the same mood that they've used in their last two albums. The fact that

CONTINUED

## MORE DISC REVIEW

*Richochet* throws a few curves into the standard theme, (the acoustic piano, the electric lead guitar) doesn't add anything new to the record so much as it shows the staleness that Tangerine Dream has fallen into.

- Richard Wadholm

### *Alpha Centauri/Atem*

Tangerine Dream

Edgar Froese, Steve Schroyder,

Chris Franke, Udo Dennebourg,

and Roland Paulyck, and

Peter Baumann.

Record One: Side One: *Aten*

Side Two: *Fauni Gena,*

*Circulation of Events*

Record Two: Side One: *Sunrise*

*in the Third System, Fly and*

*Collision of Comas Sola*

Side Two: *Alpha Centauri*

Ohr Records

OMM 556012-15 and

OMM 556031

Polydor has re-issued two of Tangerine Dream's best albums in a bargain package reminiscent of the flip-back and milestones series from Colombia.

*Alpha Centauri*, the second album, is the best example of their early period. It's difficult for ester ears to easily appreciate music so introverted and unstructured, but it does grow on you.

Side one is pure and unredeemable corn, but side two is thick and warm and richly textured, building out of sheets of subtle dissonances into crashing waves of crescendo at the end.

*Atem* is their pinnacle album, catching the group at a fleeting moment between the soft, organic cacophony of their earlier music, and the cold, ethereal symphonies of the Virgin label recordings.

The *Atem* suite, taking up side

onem is a majestic space symphony that rises from a Wagnerian opening to hushed deep webs of sound. Subtle interplay of tensions gives it movement and dynamics without having to resort to the hokey computer rock rhythms of Tangerine Dream's more recent works.

*Fauni Gena* and *Circulation of Events*, are liquid, disturbing motes of sound that draw you in through respected listening without demanding attention.

*Wahn*, at the end of side two, is the most recognizably musical piece on the album. It's a pretty downward progression ending the album on a note of gentle sadness.

Unlike most of the electronic music coming from Germany, *Alpha Centauri* and *Atem* use electronics without sounding electronic. Their style, as of these two albums, is soft, flowing, atonal starscapes, best to listen to in a dark room.

- Richard Wadholm

## MORE GUERRILLAS FROM PAGE 11

substitutes for the traditional Indian tamboura.

An aborted attempt at a career in electronics began for Paul in 1948 when he was 8 and his family was the first on the block to have a television. He had the idea that by properly hooking up a person and a television, you could read the person's thoughts. First he attached his friend to the antenna input and nothing happened; Paul figured that more voltage was needed. So he wired his friend, the TV, and a model T spark coil in series, which got him into a lot of trouble. Finally, because of societal pressure, he was forced to curtail his activities in electronics.

Two other of Paul's projects bear mentioning. First is the "Parrot

Pleaser" which he built for his parrot Joe. The parrot pulls a string and the device mounted on his stand produces a psuedo-random loop of sounds. The length of the loop is constantly changing. This pleased Joe greatly, so much in fact, that eventually the parrot learned to sing and skawk like the electronic music. Then, as the batteries ran down, until finally the "Parrot Pleaser" delivered only clicks, Joe learned to click.

On October 21st, at the San Francisco Conservatory of Music's Heleman Hall, the New Music Ensemble of that institution under the direction of John Adams presented Paul's piece, "3 by 3". This is for live performers and homemade four channel shift register. A shift register takes whatever signal is in its first channel and transfers it to the second position putting a new signal in channel one. Then, both are shifted over one more step as the third signal is introduced. The three sources for this concert will be, composed instrumental music, electronic music, and ambient sound.

In much of Paul's music there is randomness; not pure mathematical randomness, but rather psuedo-randomness. Pure randomness is not interesting to him, but something that is following a pattern, "It's like relating to another mind. Another mind isn't completely random; there are patterns there which you can't fully realize, and the interest is created between the predictable and unexpected."

Analog electronics have had a great effect on music. In fact, Paul sees analog electronics developing right along with reproducing music and making music with electronics. "Look at all the technology that came and went and never affected music." Digital electronics has yet to have the same impact and its place in music remains to be seen, but the creation of electronic guerrillas in music is truly an analog occurrence. 

MORE  
Easton

is really interesting, I think the Oberheim polyphonic is too. I think that what 360 Systems is doing with guitars is real interesting too. Right now, though, synthesizers do something which is being overlooked. They produce unique sounds which are fantastic and they're beautiful. There are millions of them and I think that's what they're here for." 

MORE  
Malcolm  
FROM PAGE 21

because they get fired up. I've found that there are a lot of people who I have never heard of, who are playing on records, when you look at the credits, you can't even find out who it was but they're doing things which are really superb. Even way back to the Beatles, there's an incredible amount of synthesizer on the Beatles, most people don't realize it, but that was incredible. I don't know who played it, whether it was George Martin, or one of the guys in the group or somebody they brought in, I don't know. But I gotta tell you there's some of the most beautiful synthesizer work."

**Bryce:** "Do you find that most of the people that utilize your studio are impressed with the magnitude of the possibilities or do you think that there's a little bit of intimidation that takes place? What kind of reactions do you get?"

**Cecil:** "It depends on the egos of the people who enter. There are two types of spirits so to speak with which one can approach Tonto — you can look at it and say, "ahhhh, what a great, ahhhh, let me at it." In other words, the challenge aspect. But for people who are perhaps a little less secure, in their ability to get into it, and people who haven't dealt with the synthesizer much, then it's a little freaky anyway; they are not expecting anything quite of the magnitude that they see in front of them, especially people who don't play keyboard too well. So you either get the one reaction or the other, the people either become intimidated or they're literally drooling. In the end, what usually

happens is, provided I can set up communication with the individual concerned, they don't have to know too much about synthesis, just a little bit about relating what they have in mind and a little cleaning up of common terms between us. We're relating pretty well from then on, they usually get what they're looking for and I can usually get close to the programs that they're talking about. Very often they'll introduce me to their sounds, they'll bring a record along and play it, "not quite like that but that sort of thing you know?" And it gives you a starting point, it's mainly vocabulary and communication between the programmer and the performer. Most of the people who come here know what they want to hear, when they come in the door. The difficulty is when they don't know what they want."

**Bryce:** "A lot of people use the phrase: 'state of the art.' What do you think at this point the state of the art is?"

**Cecil:** "Well, 'state of the art' is always an ever changing parameter;

the state of the art yesterday is different from the state of the art tomorrow. What it really means is how far have we come at this point. The state of the art today in synthesis to me is really the equipment that is available to us. People are always coming out with something that's a little bit newer and a little bit better, or with the trade off, you get a little bit more distortion but is a bit higher level. You've always got to trade one thing off against the other.

As far as pitch generation, we can get fairly close with synthesizers to accurate pitch, but good musicians often complain about the out-of-tuneness of the instrument, relative to what they're used to in terms of piano tuning, organ tuning, and fixed acoustic instrument tuning. So there's an area there that could be improved upon a lot. 'State of the art-wise', as far as creating timbres or colors are concerned, we have some excellent filtration. I still believe that the original low pass coupler and a high pass Moog unit is the most comprehensive filter available. It's a

CONTINUED

  
**Star track**  
RECORDING STUDIO

24, 16 & 8 channel recording.

Complete state of the art

Synthesizer facilities with

Expert programming and engineering.

**THE STUDIO FOR THE  
TOTAL SYNTHESIST**

Air conditioned — Adequate parking

24 hour service

8615 Santa Monica Blvd.

West Hollywood, Ca.

(213) 855-1171

MORE  
Malcolm

pity it doesn't have a voltage control of resonance and a few other things, but over all you can get the widest range of sounds out of that Moog equipment.

The real state of the art is the imagination of the synthesist, how good he is at his gig. Whether it's environmental sounds like wind, rain, and white noise, or whether it's pure pitches, it's up to the imagination of the individual. That's what's more important — the artist's use of imagination, rather than the equipment itself." 

MORE  
SOUND ARTS  
FROM PAGE 23

sitting in on the Audio/Synthesizer Design workshop taught by Jim Cooper (chief designer for Oberheim Electronics) it is easy to see how these small, closely working groups are one of the important keys to the energy level at Sound Arts.

Walter: "The workshops are people learning new things, and attempting to solve problems, often in a non-standard manner. There is a freshness of point of view, and a level of communication that results in mutual trust, which in turn leads to studio bookings, other workshops, occasional sales, and in general, an exchange that enhances everyone concerned. We offer Basic Electronic Music, Advanced Electronic Music, Audio/Synthesizer Design, and Recording Arts. Other workshops happen when needed."

Wyman: "When I'm teaching here, I like to begin with the principles of electronic music, to give an over all viewpoint of analog synthesis, some of the basic uses of digital synthesis, and uses of electronic music in both the Avant Garde and the more commercial community. We don't spend very long on principles, we apply them to the instruments at hand so that within two workshop sessions, a student can begin to actually apply the

techniques of synthesis."

I asked Dan: "What problems or limitations do you most often find in the electronic music student?"

Wyman: "I find that across the board, there's a lack of basic musical skills. There is an adage going around, which unfortunately has some truth to it, that is: that those who do not have skills on another instrument turn to the synthesizer because it is new, and they hope it will disguise their inefficiencies; and that will not suffice."

The synthesizer, more than any other instrument, has to be played with great subtlety. You've got to study your technique, you've got to know orchestration and harmony, you have to understand some principles of electronics and acoustics. Anyone who plays a synthesizer larger than a Mini-moog, has to deal with impedance, mike or line signals, and Murphy's Law (if it can go wrong, it will) and this means that a synthesist has to really have his chops together. If you know how an oscillator works, what a pole filter is, what a four pole filter is, you will see a few potential connections that you would never have seen had you not understood the electronics involved. We not only acknowledge this added dimension to the usual way synthesis is taught, but with the Audio/Synthesizer Design class, we offer an opportunity to delve heavily into the pursuit of such information."

Above all, there is a feeling around the studio of commitment to electronic music and to the creation of a positive environment where the discovery usually associated with major universities can proceed in harmony with the concrete demands of the commercial world. While no Sound Arts alumni have "hit it big" commercially yet, in the year since the workshops began, Dan Wyman has taught a growing number of professionals including: Tom Snow, Marty Mead (Manhattan Transfer), Chi Coltrane, and Bill Payne (Little Feat), as well as a large number of the people teaching electronic music in the Southern California Community Colleges.

I asked Peter Bergren and Bob Walter what they saw for Sound Arts' future in terms of expansion and change:

Bergren: "One part of expansion is in the area of equipment. Within a year, we will be 16 track with noise reduction and of course that will mean another mixer. While the basic mixing functions will be satisfied by a standard console, there will be some customizing necessary so that anything can be connected to anything else, in any kind of combination, in a compatible way, and in an extremely short interval.

What we are moving towards achieving is real time Musique Concrete. The routing of the signal to the effect processing and then back into the board in terms of mixing it with another output, and the assignment of outputs will be custom made so that it will be possible to interface the board with the rest of the studio in much the same way that synthesizer modules work. Thus the entire studio components will in effect become modules. With the aid of a digital patching system, the whole studio will be one instrument capable of processing live as well as synthesized waveforms in something resembling real time."

Walter: "There's a lot I could say about expansion, but maybe some of it has already been said. The one area I hope we will be able to show growth in, is in the time we devote to our own projects, which ironically have taken a back seat to the crush of daily doings. You know it's curious but right now we seem to be on a pivot point. Dan just finished writing the Moog Modular Synthesizer Manual, we just purchased the property our studio is on, the EMQ just finished its first series of concerts, and while Sound Arts continues to grow in the slow and steady way it has, there are also some almost disquieting indications that things may suddenly mushroom."

In any case, this article is a good bookmark to note the end of the first phase in Sound Arts, the studio communities' development. 

## MORE SAMPLE & HOLD

performer the ability to do studio effects in concert.

The Electric Sax is a device that incorporates all of the major functions of an acoustical instrument as far as frequency and tone control goes. This is done with a mouthpiece that has sensors for air and lip pressure. The mouthpiece has no reed but has the same feel of a normal sax mouthpiece; yet, the sax is a synthesizer with all the possibilities that accompany that title. For the development of these instruments, Serge is working in partnership with Frank Eventoff, who Serge feels is a "fantastic" musician and instrument designer.

I asked Serge if he preferred one esthetic approach to synthesizers over another. He answered by saying that as a synthesizer designer, he has taken a step outside of music and is able to design for, and appreciate equally, all types of music.

Serge's musical philosophy is best summed up in his own words: "If you talk about tradition, I'm moving in the tradition of new music. I have expanded my concept in the years to include all new music. I am just as happy to hear new pop music as I am to hear new classical music. My main interest is creating new sounds and creating the equipment to produce these new sounds. That's why I think of computer controlled electronic music. I have this mental picture of a composer in his own personal studio where he can realize his fantasies and produce tone paintings, just like a painter puts out canvasses. The final outcome of electronic music for me, is the ability to do it all yourself. That's a fundamental aspect that electronics has brought to music. The composer has total control all the way up to the final end product. He has control all the way from thinking about and working out a piece, all the way up to the listening of that piece."

## POP WORKS

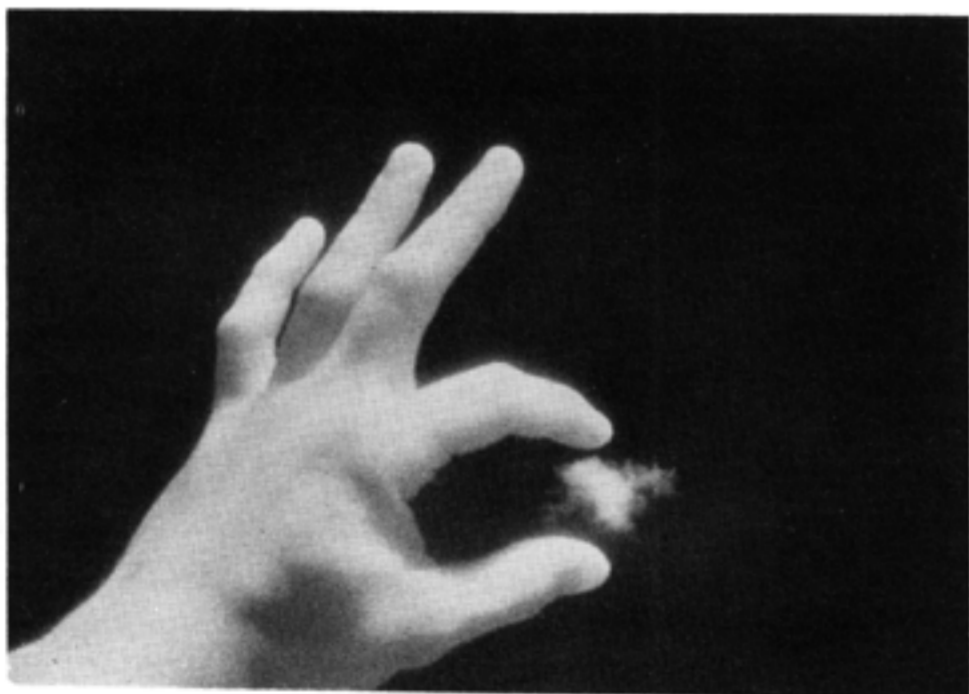

fine arts and other fine

**PHOTOGRAPHY**

**Bill Matthias – Los Angeles**

(213) 986-3951

## MORE LISTINGS

### SCHOOLS

BOSTON SCHOOL OF  
ELECTRONIC MUSIC  
326 Dartmouth Ave., Boston,  
Mass. 02116  
(617) 261-1634

CONTEMPO MUSIC GUILD  
13273 Ventura Blvd., Studio City,  
Calif. 91604  
(213) 784-8271

DICK GROVE MUSIC  
WORKSHOPS  
12754 Ventura Blvd., Suite 2,  
Studio City, Calif. 91604

LOS ANGELES CENTER FOR  
ELECTRONIC MUSIC  
Box 1594, Hollywood, Calif. 90028  
(213) 463-8772

SOUND ARTS  
2825 Hyans St., Los Angeles, Calif.  
90026  
(213) 487-5148

SHERWOOD OAKS EXPERI-  
MENTAL COLLEGE  
6353 Hollywood Blvd., Hollywood,  
Calif. 90028  
(213) 462-0669

# lem



## THE SYNTHESIZER BAND

For Information and Booking  
call or write:

**Moldar Productions**  
1670 N. Crescent Heights Blvd.  
Los Angeles, Cal. 90069  
(213) 654-3755

# BOOK REVIEW

## "Electronic Projects for Musicians"

by Craig Anderton 1975, \$6.95  
Guitar Player Productions: P.O. Box 615,  
Saratoga, CA 95057

For so long now, a large gap has existed in electronic music literature. There are books that describe electronic music history, personalities, equipment and techniques, and there are books that describe electronic music in terms of advanced circuit design and the foreboding elements and calculation of physics. Unfortunately, much of the important information that we all need falls in between. This information gap, more than anything else, has frustrated the average electronic musician.

In "Electronic Projects for Musicians," Craig Anderton has applied his diverse background to writing a circuit design book that can be understood and utilized by even a novice electronic musician. As a writer for *Guitar Player*, *Popular Electronics*, *Electro-*

*notes*, *Polyphony*, and of course, *Synapse*, Anderton has gained a clear understanding of the needs of electronic musicians not met in other books of this kind.

"Electronic Projects for Musicians" starts with simple explanations of electronic components, connectors, reading schematics, safety, buying parts and packaging your creation. Then comes easy to understand projects such as, a pre-amplifier; compressor; ring modulator; dual tone filter; electronic foot switch system; tuning standard oscillator; and an eight in, one out mixer.

If you have ever wanted high db amplifier distortion at low db gain, or the ability to switch in effects or mix more instruments than there are inputs, or just to tune A 440, this is the book for you. When you think about it, besides the information and projects contained, this book prepares you for moving into the wide open spaces of electronic music circuit design. On that basis alone, one would have to congratulate Mr. Anderton.

"Electronic Projects for Musicians" came highly recommended to this author, and I second the motion.

- Phil Terr

## CLASSIFIED ADS

20 words for \$2.00

to: **SYNAPSE/  
Classified Ads**  
P.O. Box 359  
North Hollywood,  
Ca. 91603

### Electronic Music Schools and Programs

Please send a description of your courses, services, philosophies, and equipment status to *Synapse*. Be part of our Electronic Music Education listing.

#### SYNAPSE

EM Education Directory  
P.O. Box 359  
North Hollywood, Calif. 91603

**FOR SALE:** Electronic Music Labs' EML 500 Keyboard Synthesizer. Factory modified: interfaces to EML 400/401, foot pedals, phase-lock, etc. Loaded with features for live or studio use now, and a versatile foundation for future expansion. Super value at \$600.00. (214) 368-6846

**WANTED:** Oberheim DS-2 or 2-A digital Sequencer; Oberheim expander module and 360 Systems Frequency Shifter, by U.S.C. student with limited funds. — Mark (213) 746-1633

### Composers and Performers

Let us know who you are and what it is that you are doing out there with electronic music. We are compiling a reference file on all electronic music composers and performers. We need your help to be complete. Send all information to:

#### SYNAPSE

Compser/Performer  
P.O. Box 359  
North Hollywood. 91603

**Quantum, New World.** An album of electronic and contemporary music that takes you on an exploratory voyage into the sonic realm of dreams, nightmares and wishes.

Send \$6.00/album to:

Quantum  
c/o John Borowicz  
5B Mt. Vernon Dr.  
Vernon, Ct. 06066

Make checks payable to: John Borowicz and please allow 3-4 weeks for delivery.

Music Copying  
24 HRS.

Electronic Music  
also:

Record and Tape Transcriptions  
Leadsheets  
Parts  
Scores  
(etc.)

Lori London (213) 981-7238

expert

**SYNTHESIZER**  
programming  
and  
instruction

STATE-OF-THE-ART EQUIPMENT

**(213) 463-8772**

# **FREE SEQUENCER!**

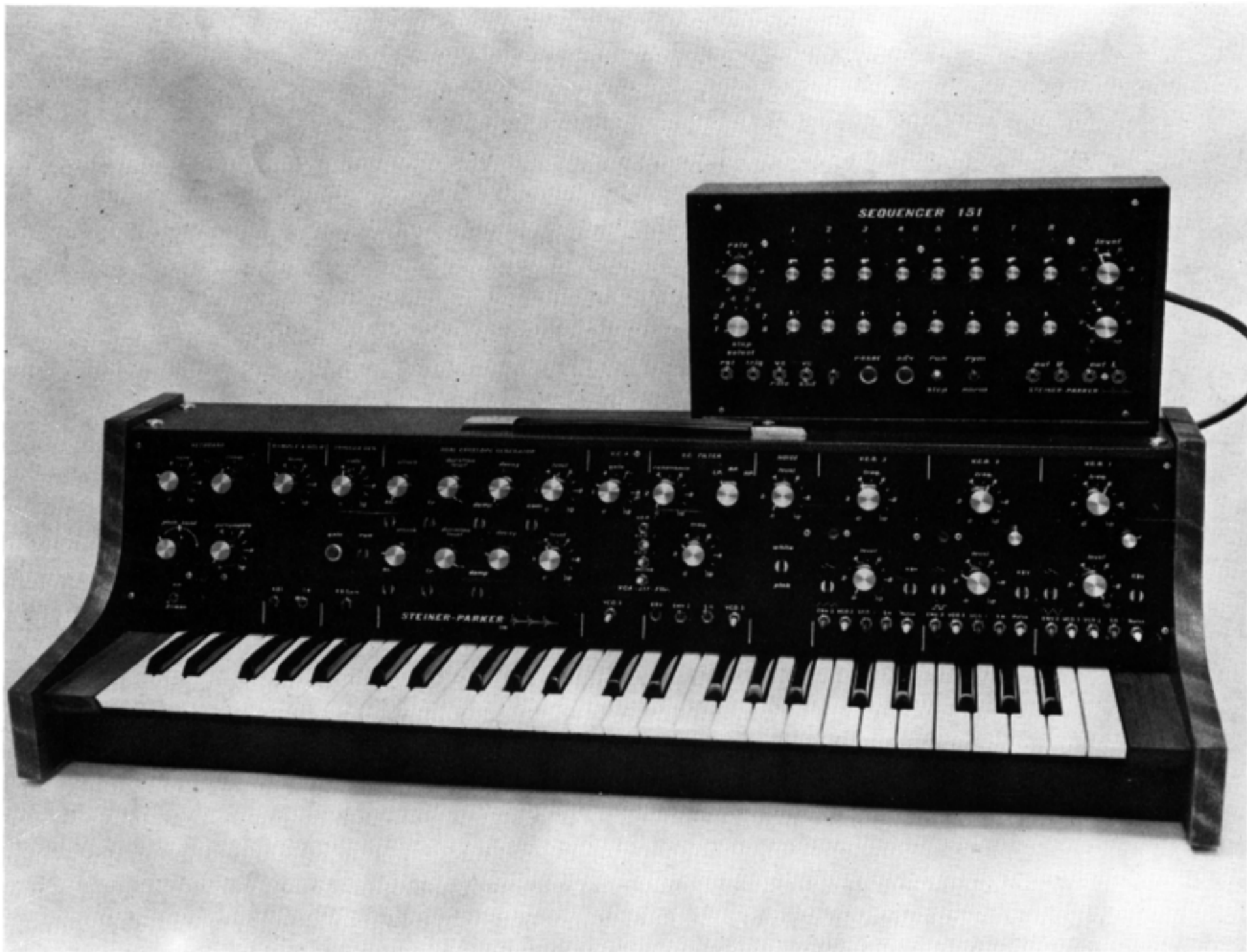

*The Synthacon and Sequencer 151*

*Buy a 2 voice Synthacon and we will send you a Sequencer 151 (\$528 list value) FREE! Offer expires Christmas Day 1976.*

**STEINER-PARKER** 2258 South 2700 West, Salt Lake City, Utah 84119 (801) 972-1447

BULK RATE  
U. S. POSTAGE  
P A I D  
No. Hollywood, CA  
PERMIT NO. 456

THE  
ELECTRONIC  
MUSIC  
MAGAZINE

**1977**

THE YEAR OF THE

**SYNTHESIZER**

SUBSCRIBE TO

**SYNAPSE**

AND

**FIND OUT WHY**

